



Spare Parts Catalog

6 HP 26

()

Material number: 1068.010.026

Current date: 24.03.2026

ZF Friedrichshafen AG
Hauptverwaltung
80038 Friedrichshafen
Deutschland

Telefon: +49 7541 77-0

Telefax: +49 7541 77-908000

www.zf.com

zuständiges Werk:
Saarbrücken

Technical Cover

Page 2 from 2

Material number: 1068.010.026



6 HP 26 / ()

Pos.	Information	Amendment number
040	CONSERVATION SPECIFICATION ZFN 916	
041	OIL CAPACITY HEAT EXCHANGER .45 dm3	
042	OIL TYPE HEAT EXCHANGER ALLOWED ATF M-1375.4	
046	Alias ID -----	
047	Bayerische Motoren Werke (BMW) 2400-7523071	

Picture

Page 1 from 1

Material number: 1068.010.026

Picture: 114.01.11-1

Material-assembly-group-no: 1068.101.895



6 HP 26 / ()
TRANSMISSION HOUSING

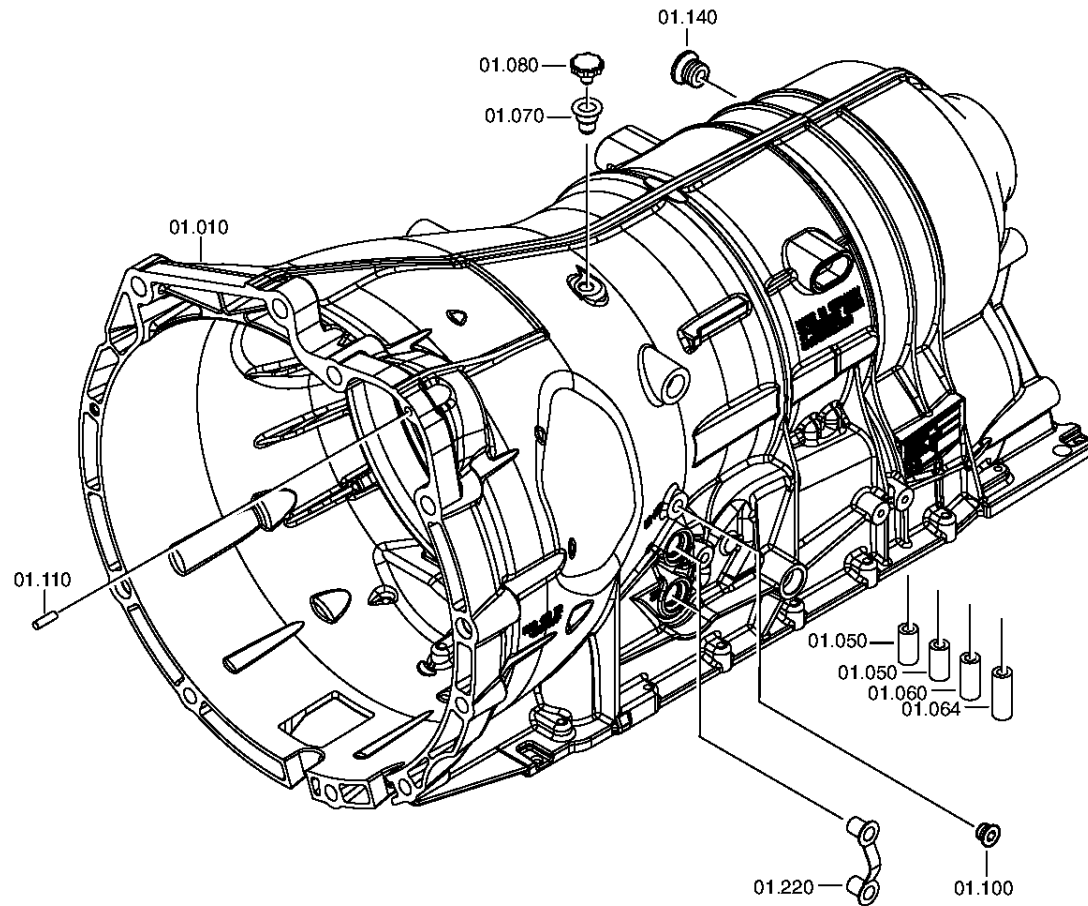

6 HP 26
BMW
M57

Parts list

Page 1 from 1

Material number: 1068.010.026

Picture: 114.01.11-1

Material-assembly-group-no: 1068.101.895



6 HP 26 / ()

	Pos.	Material number	Customer material	Name	Quantity	ME	Amend. no.	Techn. Info.	Rep kit	Alternative material
🛒	10	1068.301.157		TRANSMISSION HOUSING	1			M57		
🛒	50	0734.317.370		SEALING SLEEVE	2			A=25,90 IN 0734 317 362(2)		
🛒	60	0734.317.371		SEALING SLEEVE	1			A=31,40 IN 0734 317 362(2)		
🛒	64	0734.317.372		SEALING SLEEVE	1			A=40,70 IN 0734 317 362(2)		
🛒	70	0501.314.851		BREATHER TUBE	1					
🛒	80	0501.314.809		BREATHER COVER	1					
🛒	100	0501.321.921		SCREW PLUG	1			M10X1		
🛒	110	0631.306.047		CYLINDRICAL PIN	1			6X20		
🛒	140	0501.321.922		SCREW PLUG	1					
	220	---		PLUG	1			D=15,20		
🛒	---	0501.320.617		PLUG	1					

Picture

Page 1 from 1

Material number: 1068.010.026

Picture: 114.03.01-1

Material-assembly-group-no: 1068.103.826



6 HP 26 / ()
OIL PAN

Bildtafel:
Figure: 114.03.01
Figure:
Figura:

Ölwanne
Oil sump
Carter d'huile
Coppa dell'olio

* je nach Stücklistenausführung
depending on spec. number
suivant la nomenclature
secondo la distinta base

07-03-06

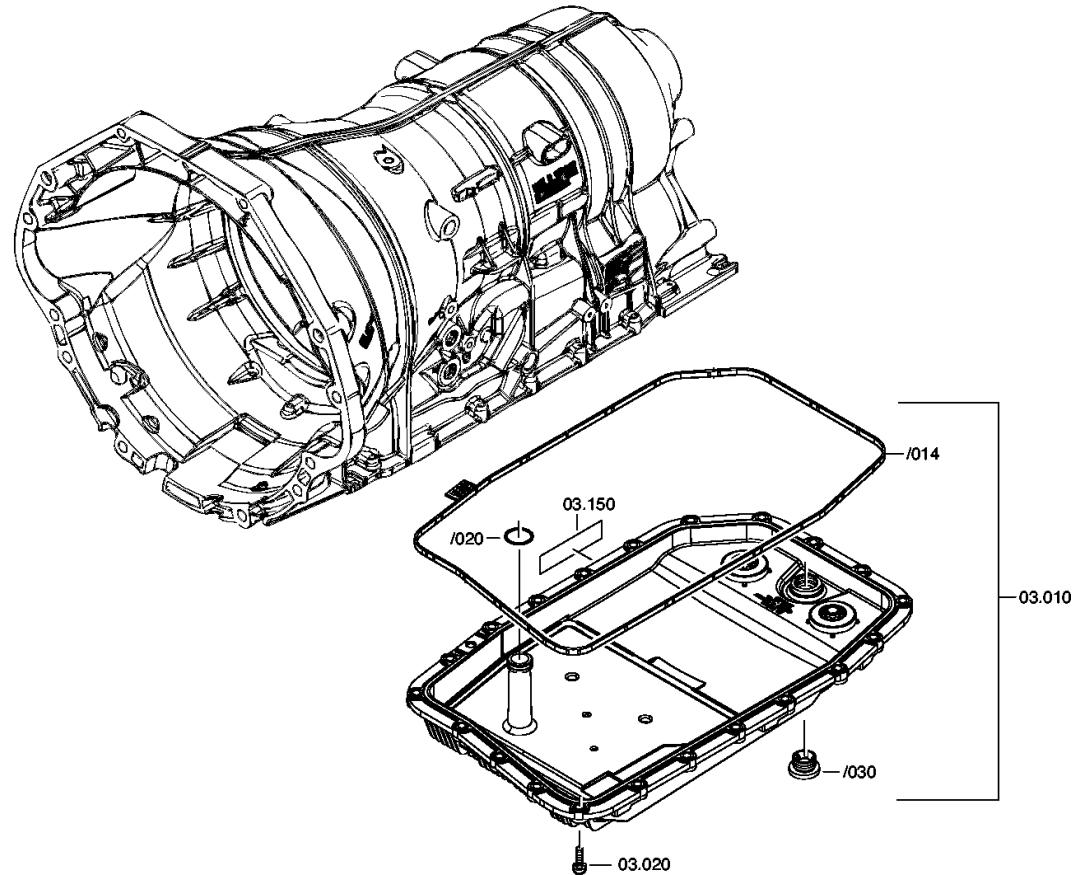

6 HP 26
6 HP 28 / X
6 HP 32
BMW

Picture

Page 1 from 1

Material number: 1068.010.026

Picture: 114.06.01-1

Material-assembly-group-no: 1071.106.806



6 HP 26 / ()
SHIFT SYSTEM

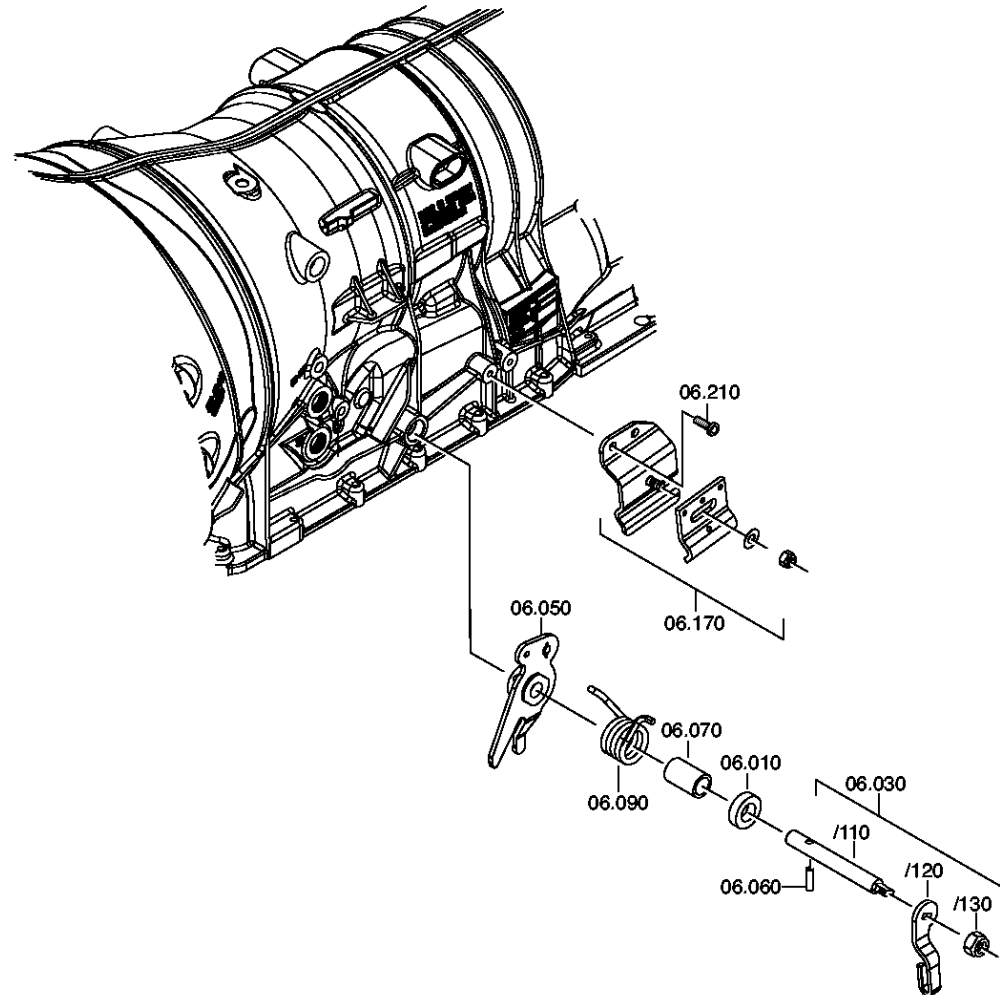

6 HP 19
6 HP 26
6 HP 32
BMW

Picture

Page 1 from 1

Material number: 1068.010.026

Picture: 114.10.01-1

Material-assembly-group-no: 1068.110.077



6 HP 26 / ()
OIL SUPPLY

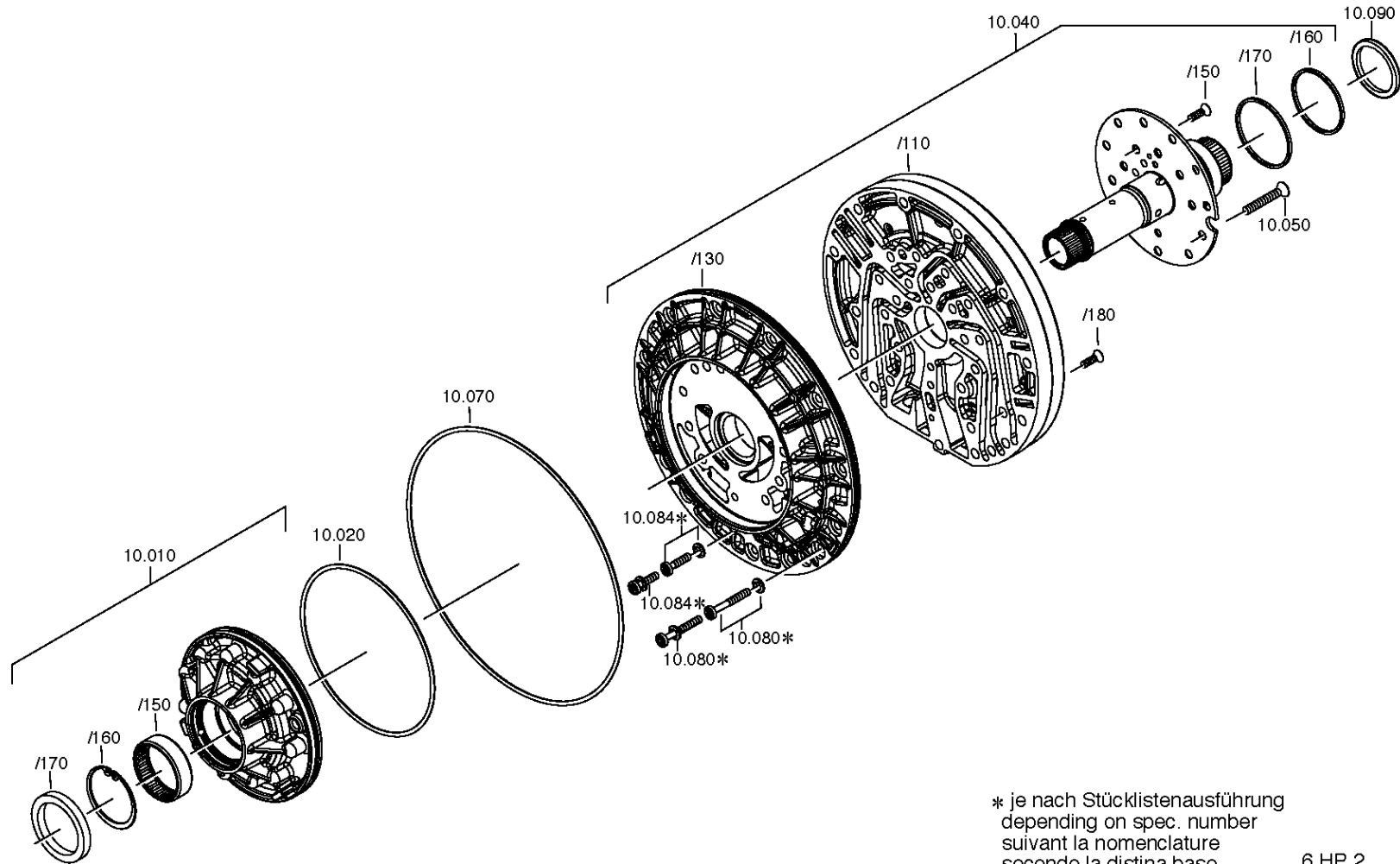

* je nach Stücklistenausführung
depending on spec. number
suivant la nomenclature
secondo la distinta base 6 HP 2...

Picture

Page 1 from 1

Material number: 1068.010.026

Picture: 114.14.01-1

Material-assembly-group-no: 1068.114.844



6 HP 26 / ()
OUTPUT

Bildtafel:
Figure: 114.14.01
Figure:
Figura:

Abtrieb
Output
Sortie
Uscita

* je nach Stücklistenausführung
depending on spec. number
suivant la nomenclature
secondo la distinta base

08-05-06

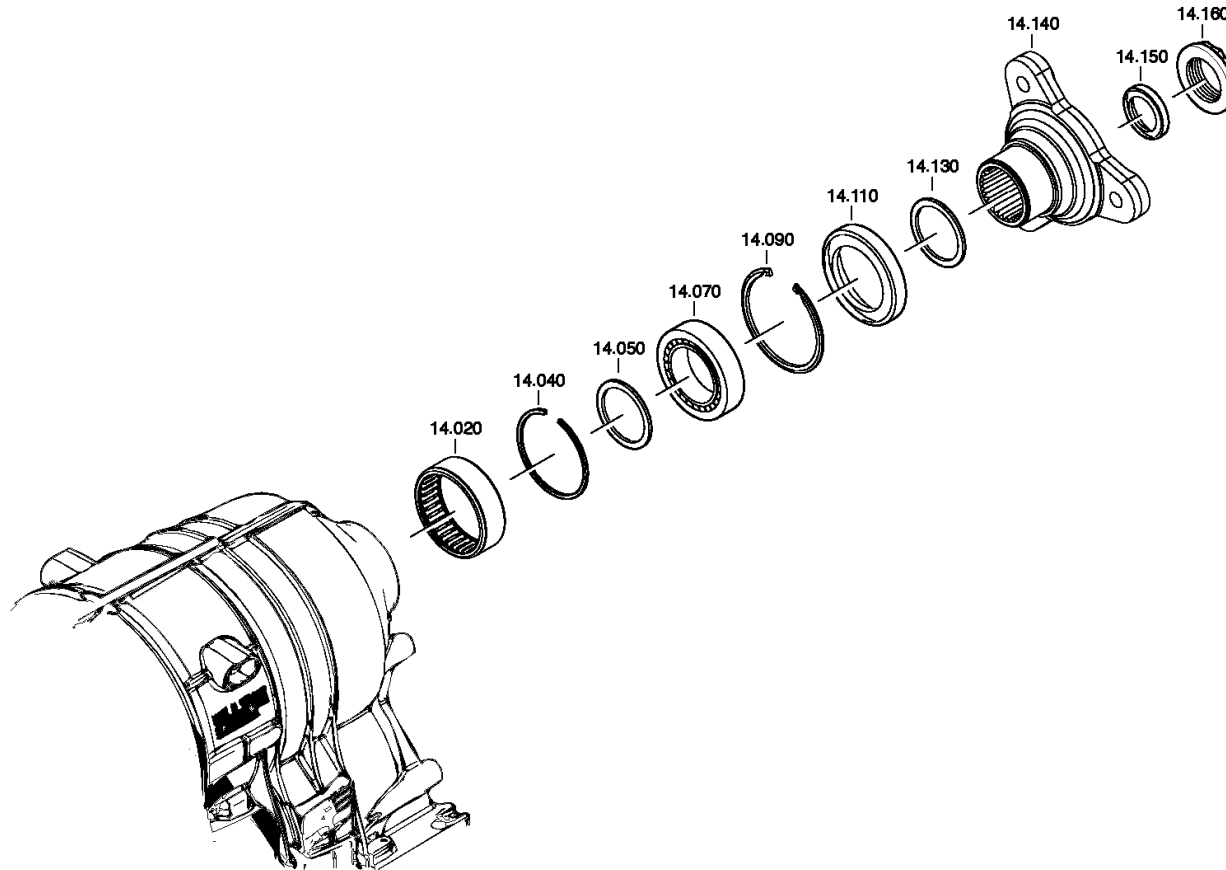

6 HP 26
BMW

Picture

Page 1 from 1

Material number: 1068.010.026

Picture: 114.22.01-1

Material-assembly-group-no: 1068.122.883



6 HP 26 / ()
CONVERTER

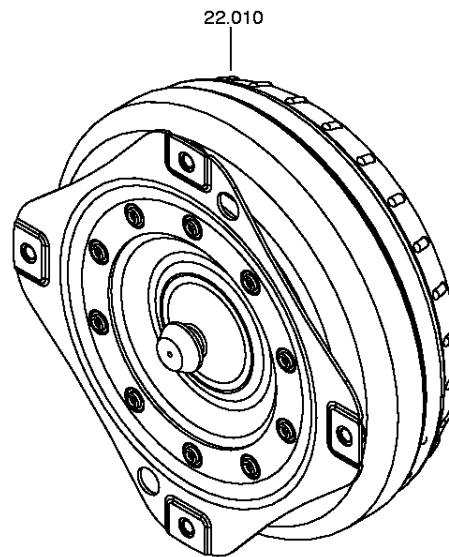

6 HP 26
BMW

Picture

Page 1 from 1

Material number: 1068.010.026

Picture: 114.24.01-1

Material-assembly-group-no: 1068.124.804



6 HP 26 / ()
PARKING LOCK

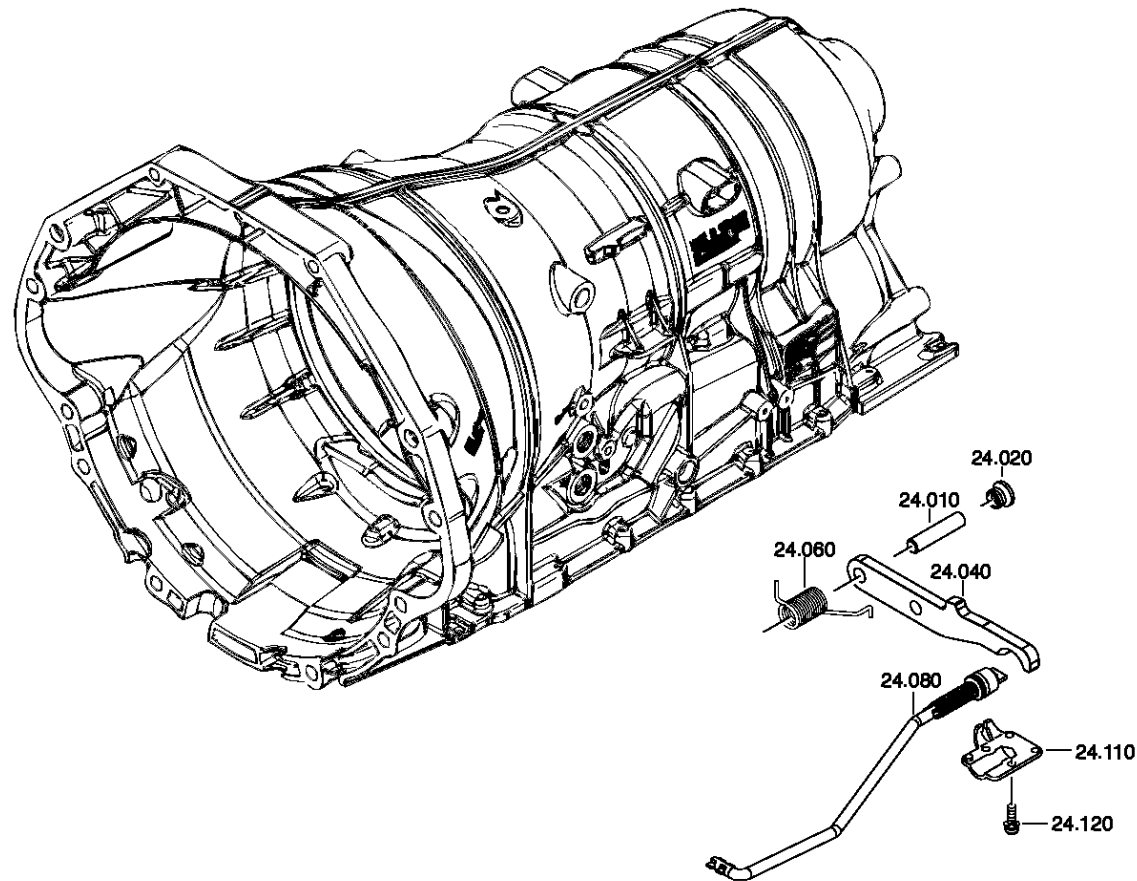

6 HP xx

Picture

Page 1 from 1

Material number: 1068.010.026

Picture: 114.27.21-1

Material-assembly-group-no: 1068.127.836



6 HP 26 / ()
MECHATRONIC

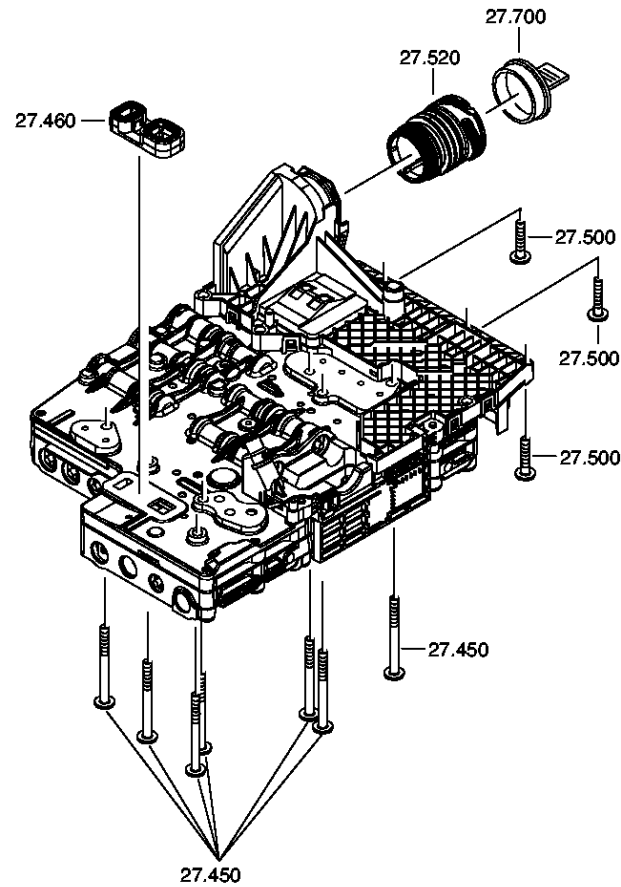

6 HP 26 / X
6 HP 32

Picture

Page 1 from 1

Material number: 1068.010.026

Picture: 114.D4.01-1

Material-assembly-group-no: 1068.128.380



6 HP 26 / ()
MECHATRONIC

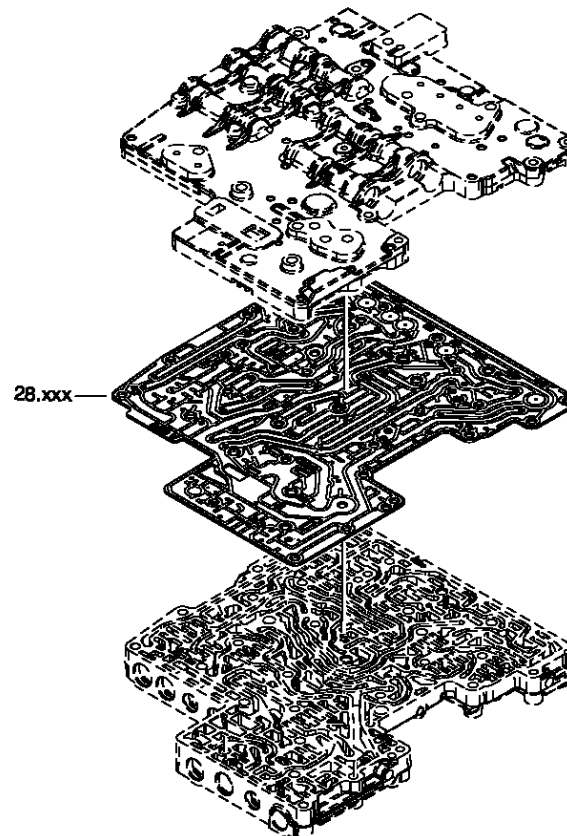

6 HP xx

Picture

Page 1 from 1

Material number: 1068.010.026

Picture: 114.32.11-1

Material-assembly-group-no: 1068.132.006



6 HP 26 / ()
PLANETARY DRIVE

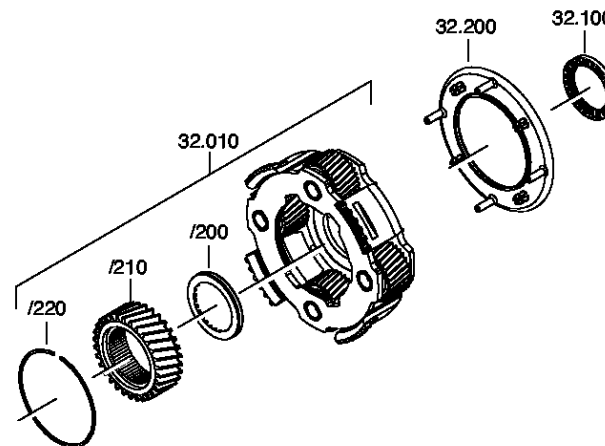

6 HP xx

Picture

Page 1 from 1

Material number: 1068.010.026

Picture: 114.42.01-1

Material-assembly-group-no: 1068.142.006



6 HP 26 / ()
PLANETARY DRIVE

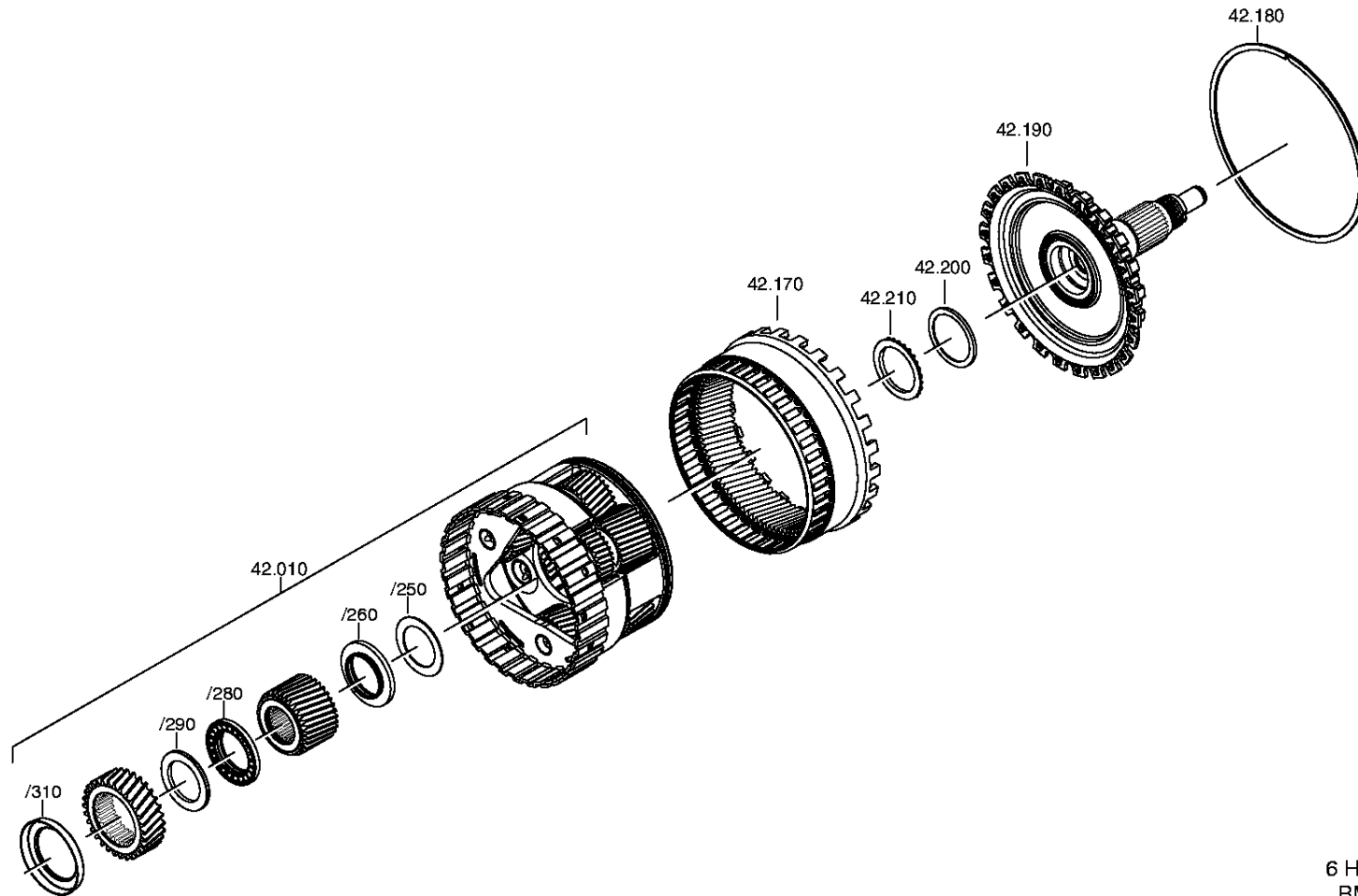

6 HP 26
BMW

Picture

Page 1 from 1

Material number: 1068.010.026

Picture: 114.70.01-1

Material-assembly-group-no: 1068.170.054



6 HP 26 / ()
COUPLING

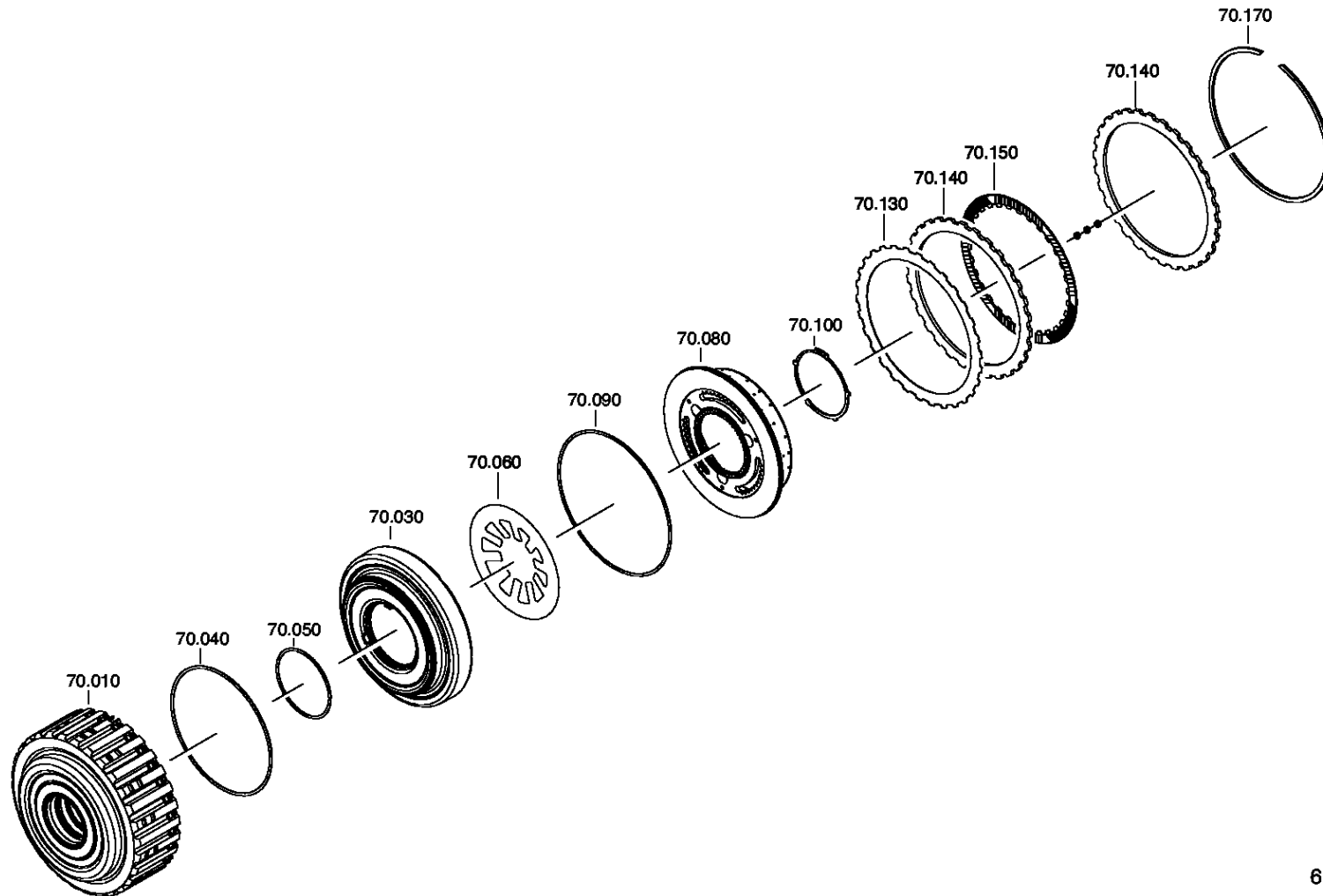

6 HP xx

Picture

Page 1 from 1

Material number: 1068.010.026

Picture: 114.71.01-1

Material-assembly-group-no: 1068.171.042



6 HP 26 / ()
COUPLING

Bildtafel:
Figure: 114.71.01
Figure:
Figura:

Kupplung E
Coupling
Embrayage
Frizione

* je nach Stücklistenausführung
depending on spec. number
suivant la nomenclature
secondo la distinta base

04-07-12

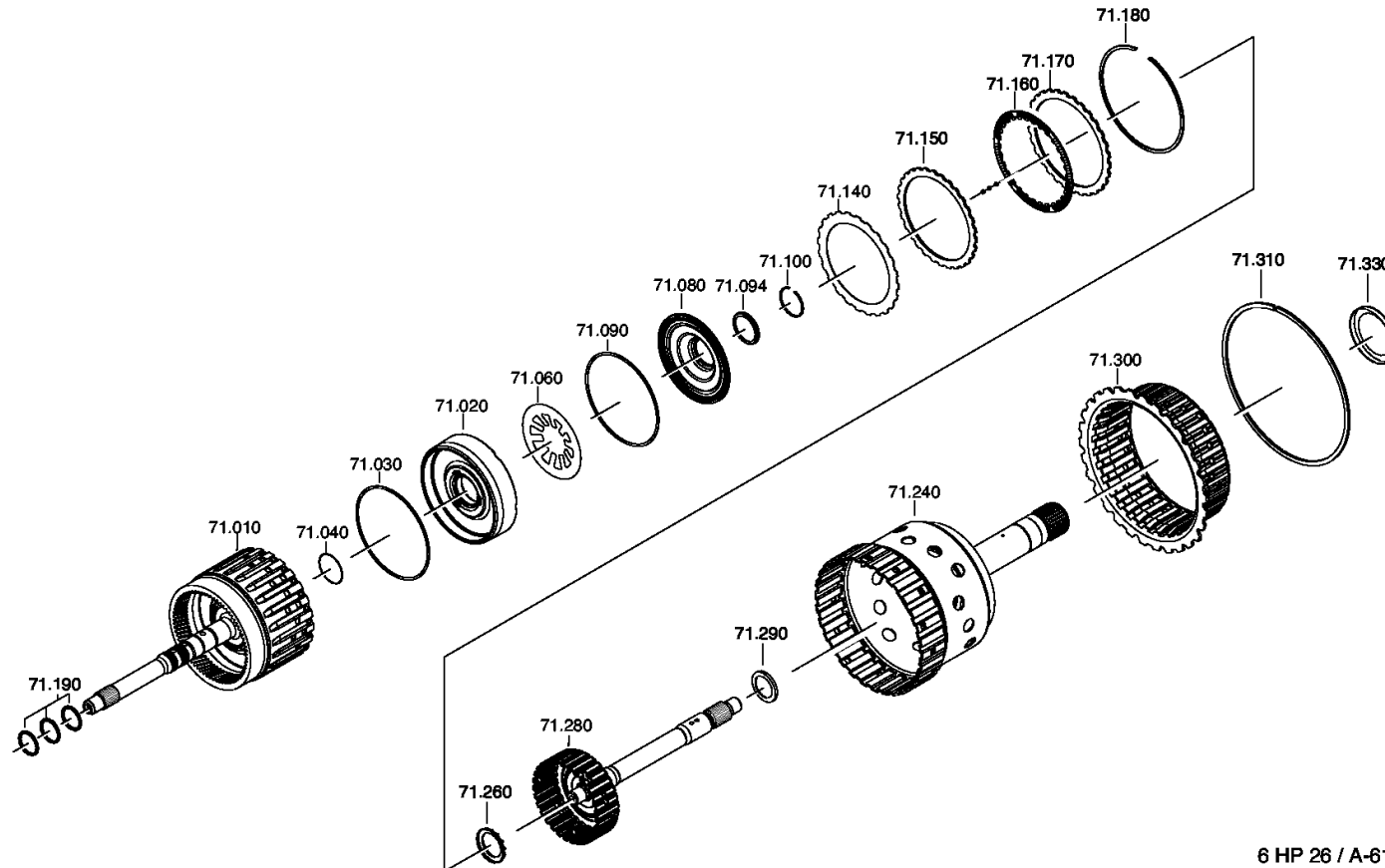

6 HP 26 / A-61

Picture

Page 1 from 1

Material number: 1068.010.026

Picture: 114.72.01-1

Material-assembly-group-no: 1068.172.017



6 HP 26 / ()
COUPLING

Bildtafel:
Figure: 114.72.01
Figure:
Figura:

Kupplung B
Coupling
Embrayage
Frizione

* je nach Stücklistenausführung
depending on spec. number
suivant la nomenclature
secondo la distinta base

04-07-13

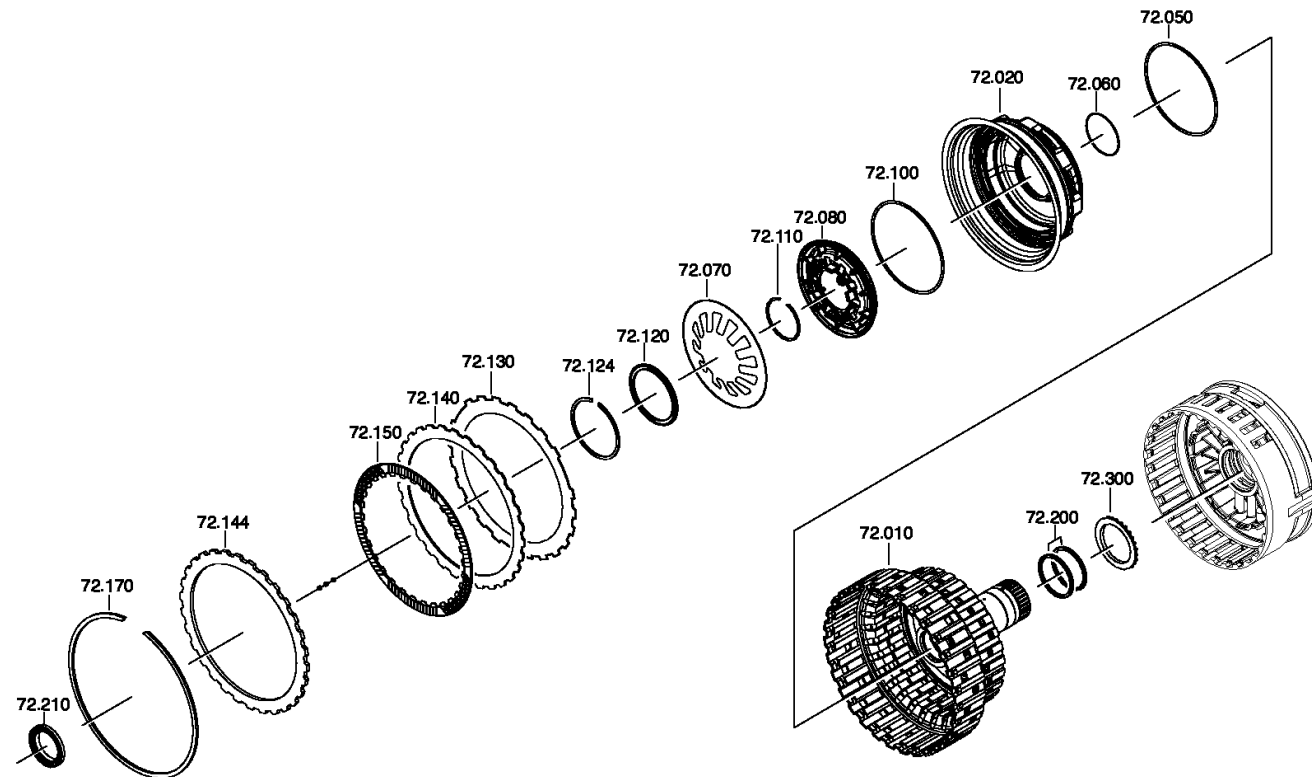

6 HP 26 / X
6 HP 26 A-61

Picture

Page 1 from 1

Material number: 1068.010.026

Picture: 114.73.03-1

Material-assembly-group-no: 1068.173.010



6 HP 26 / ()
COUPLING

Bildtafel:
Figure: 114.73.03
Figure:
Figura:

Bremse D
Brake
Frein
Freno

* je nach Stöcklistenauflösung
depending on spec. number
suivant la nomenclature
secondo la distinta base

08-04-28

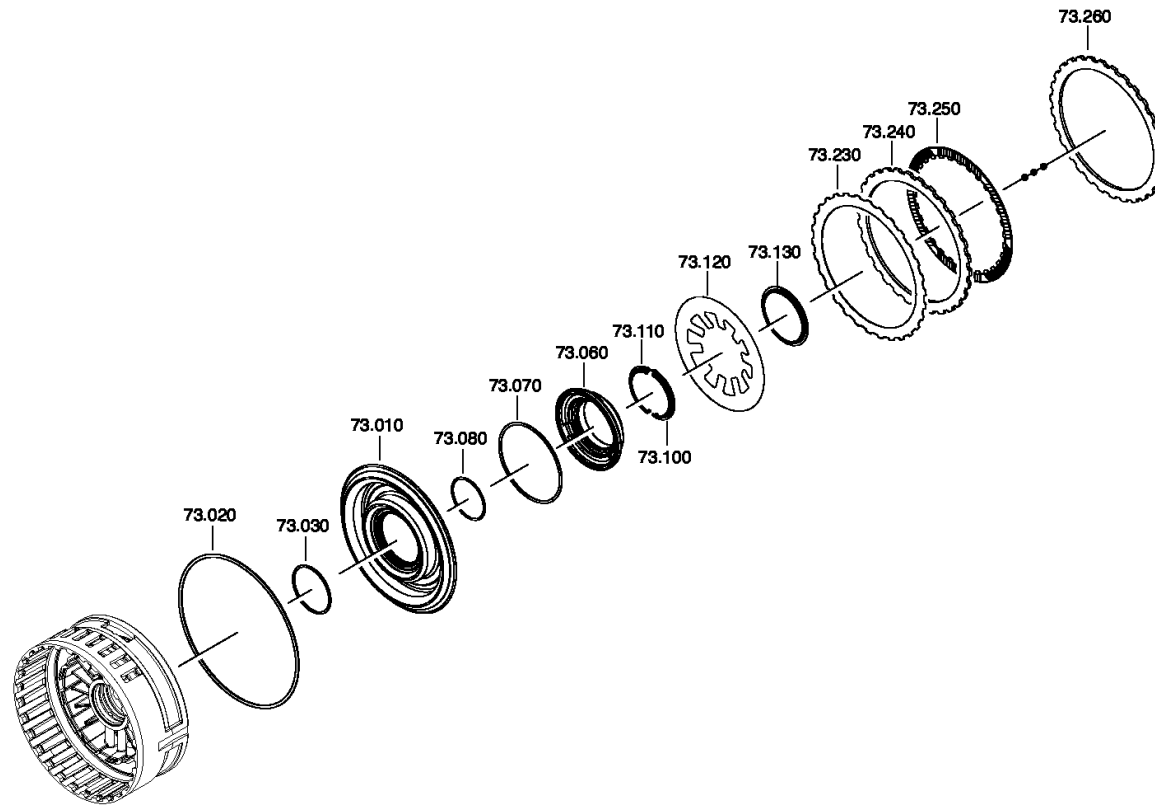

Picture

Page 1 from 1

Material number: 1068.010.026

Picture: 114.75.03-1

Material-assembly-group-no: 1068.175.800



6 HP 26 / ()
COUPLING

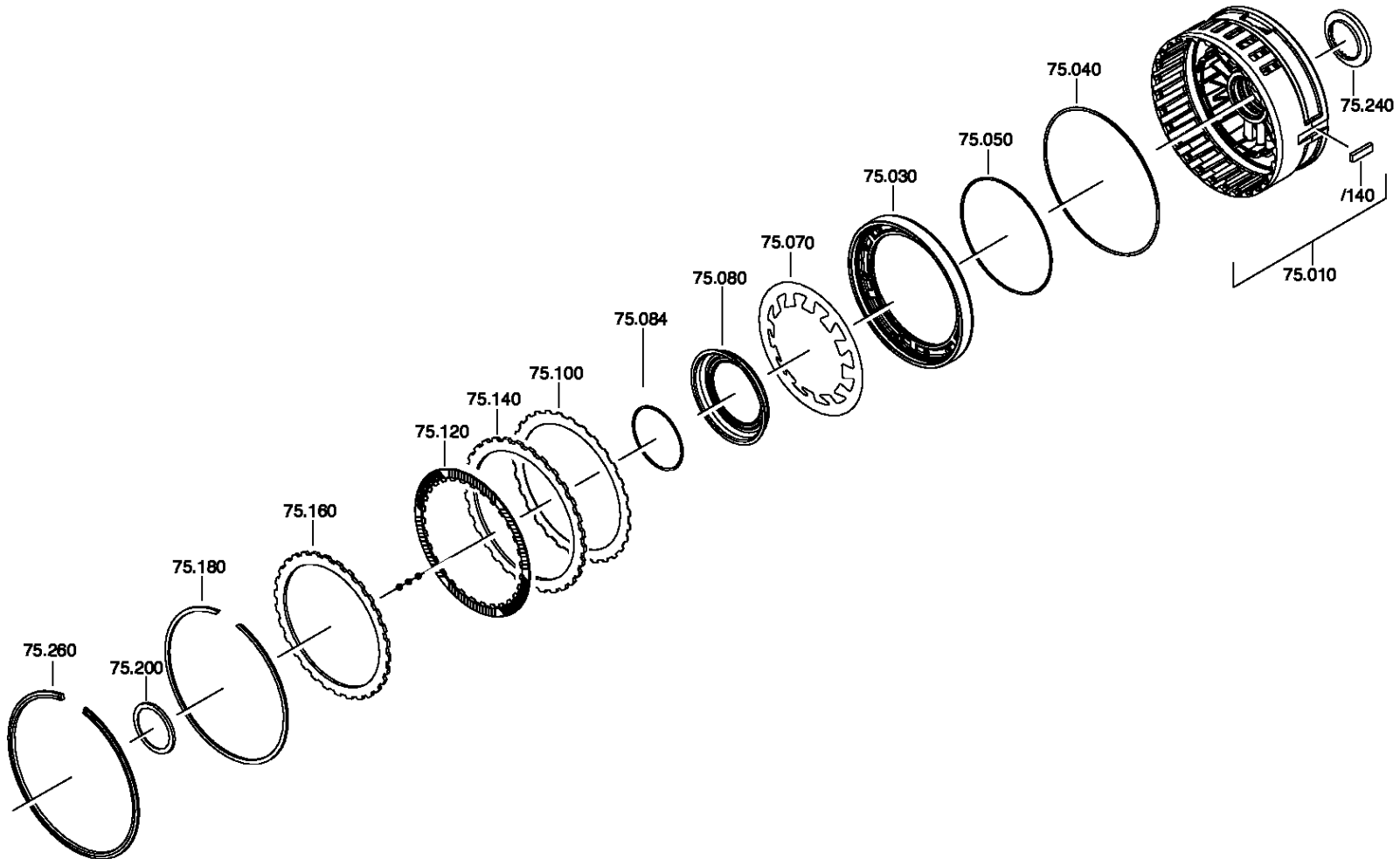

Picture

Page 1 from 1

Material number: 1068.010.026

Picture: 114.92.51-1

Material-assembly-group-no: 1068.192.018



6 HP 26 / ()
CONSERVATION

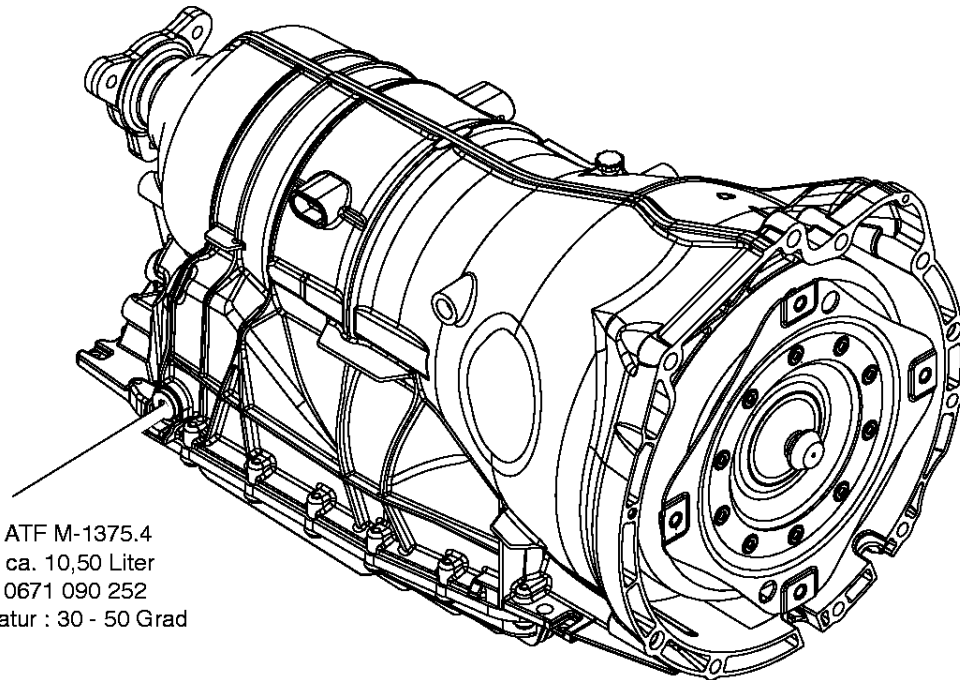

Getriebe-Oel : ATF M-1375.4
Oelmenge : ca. 10,50 Liter
Teile-Nr. : 0671 090 252
Befuelltemperatur : 30 - 50 Grad
auf Ueberlauf

6 HP 26
BMW M57

Picture

Page 1 from 1

Material number: 1068.010.026

Picture: 114.97.11-1

Material-assembly-group-no: 1068.197.908



6 HP 26 / ()
PACKING

Bildtafel:
Figure: 114.97.11
Figure:
Figura:

Verpackung
Packing
Tole de verrouillage
Lamiera di bloccaggio

* je nach Stücklistenausführung
depending on spec. number
suivant la nomenclature
secondo la distinta base

02-06-12

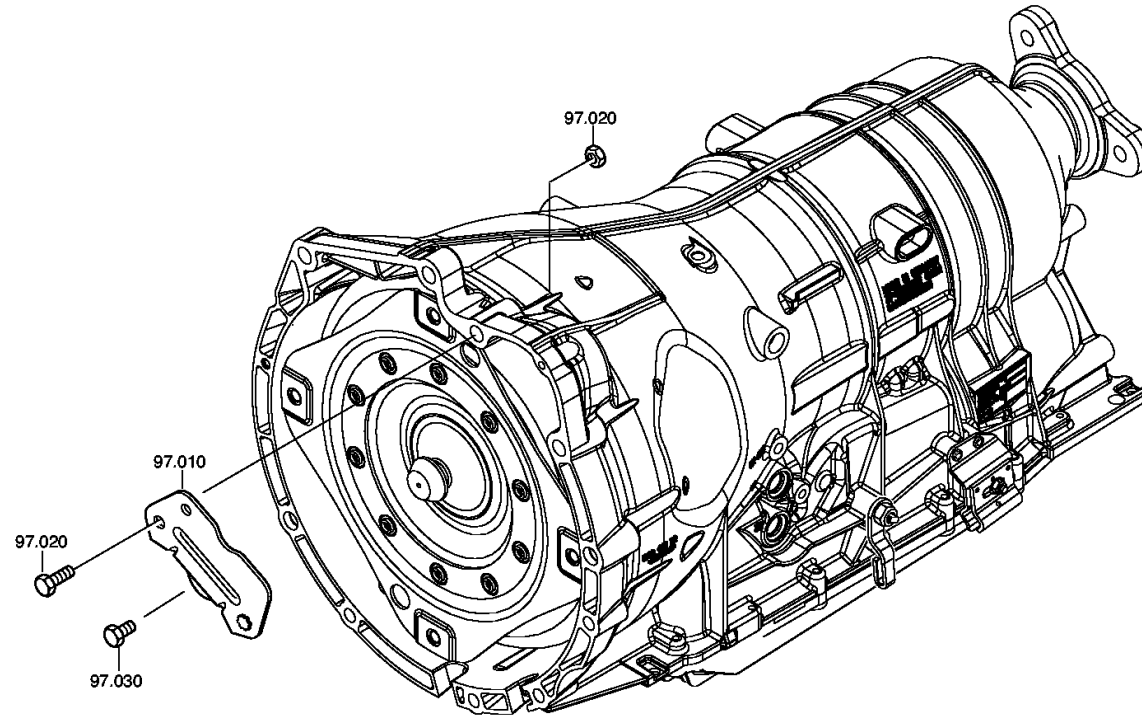

6 HP 26
BMW M57

Picture

Page 1 from 1

Material number: 1068.010.026

Picture: 114.G6.01-1

Material-assembly-group-no: 1068.298.043



6 HP 26 / ()
PRESSURE REGULATOR

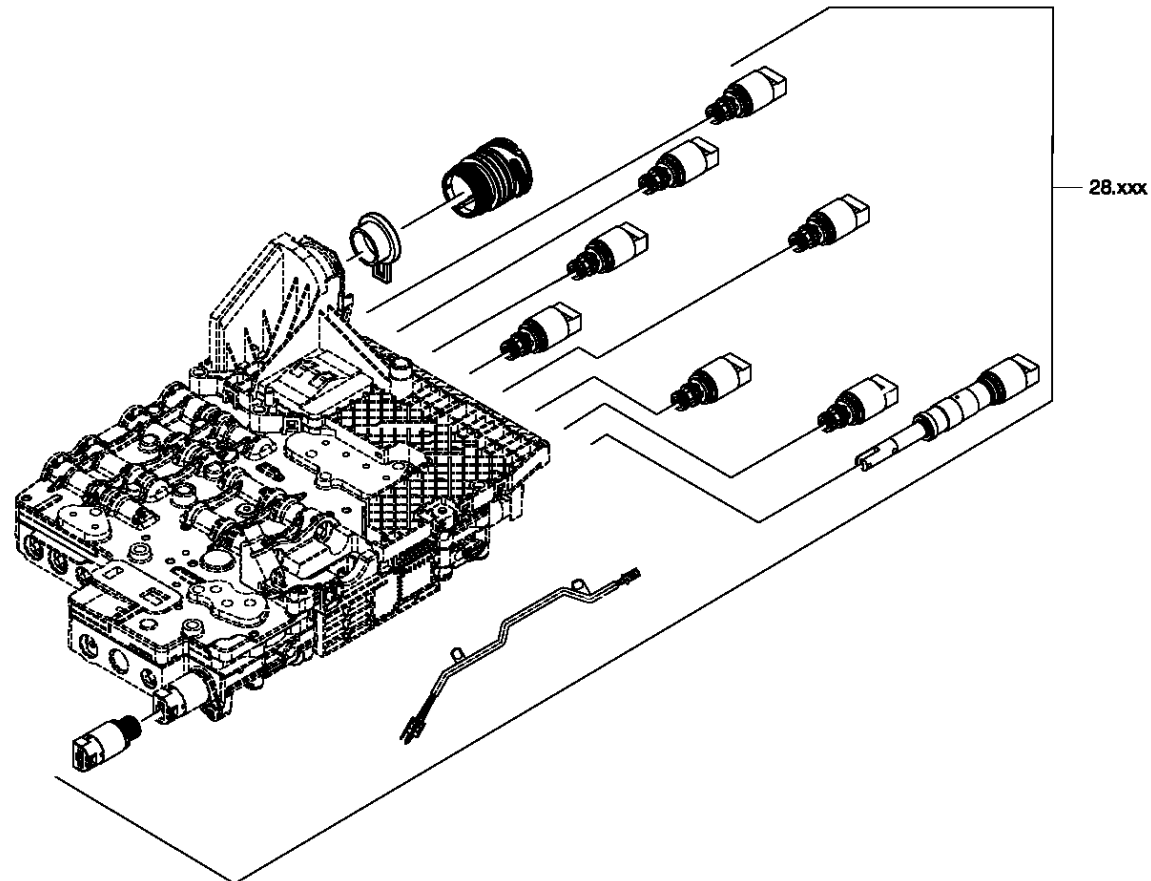

6 HP xx
E-Sch.

Picture

Page 1 from 6

Material number: 1068.010.026

Picture: 114.G6.01-1

Material-assembly-group-no: 1068.298.043



6 HP 26 / ()
PRESSURE REGULATOR

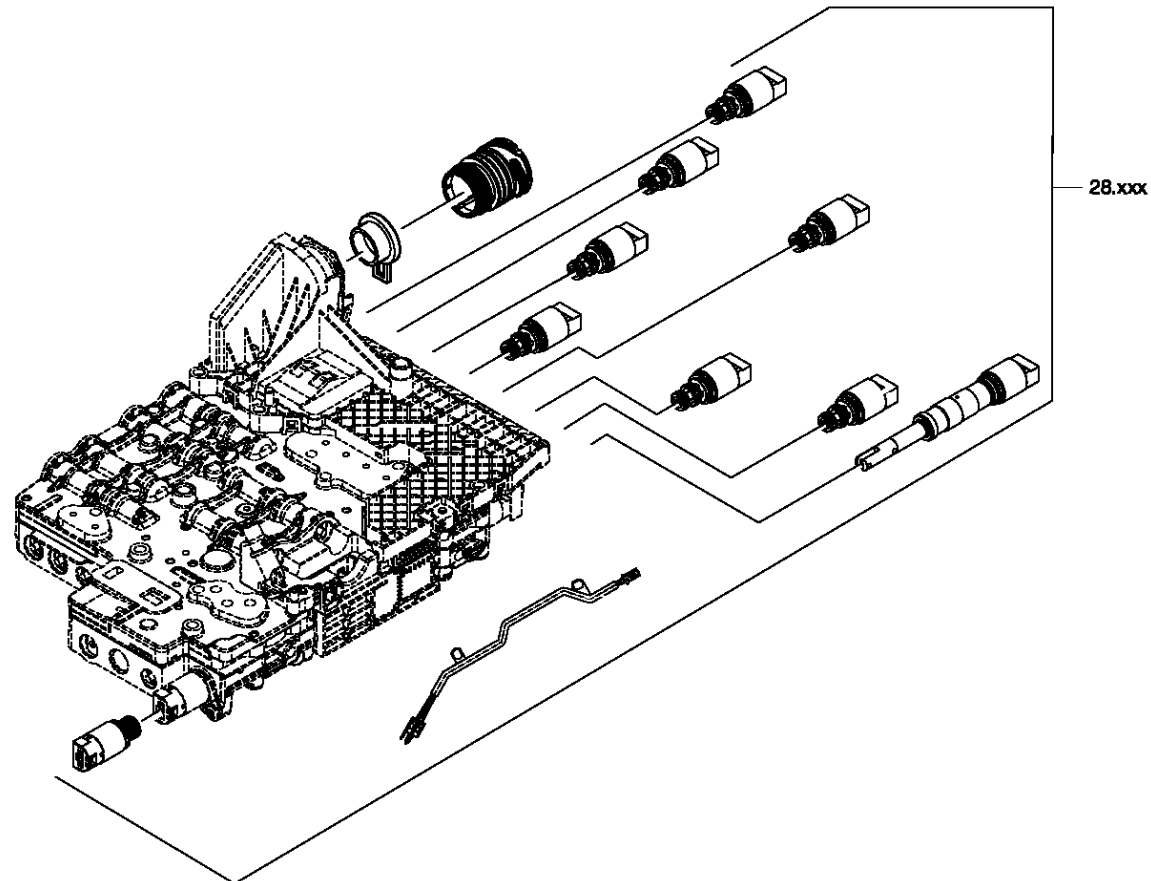

6 HP xx
E-Sch.

Picture

Page 3 from 6

Material number: 1068.010.026

Picture: 1068_298_609-2

Material-assembly-group-no: 1068.298.043



6 HP 26 / ()
PRESSURE REGULATOR

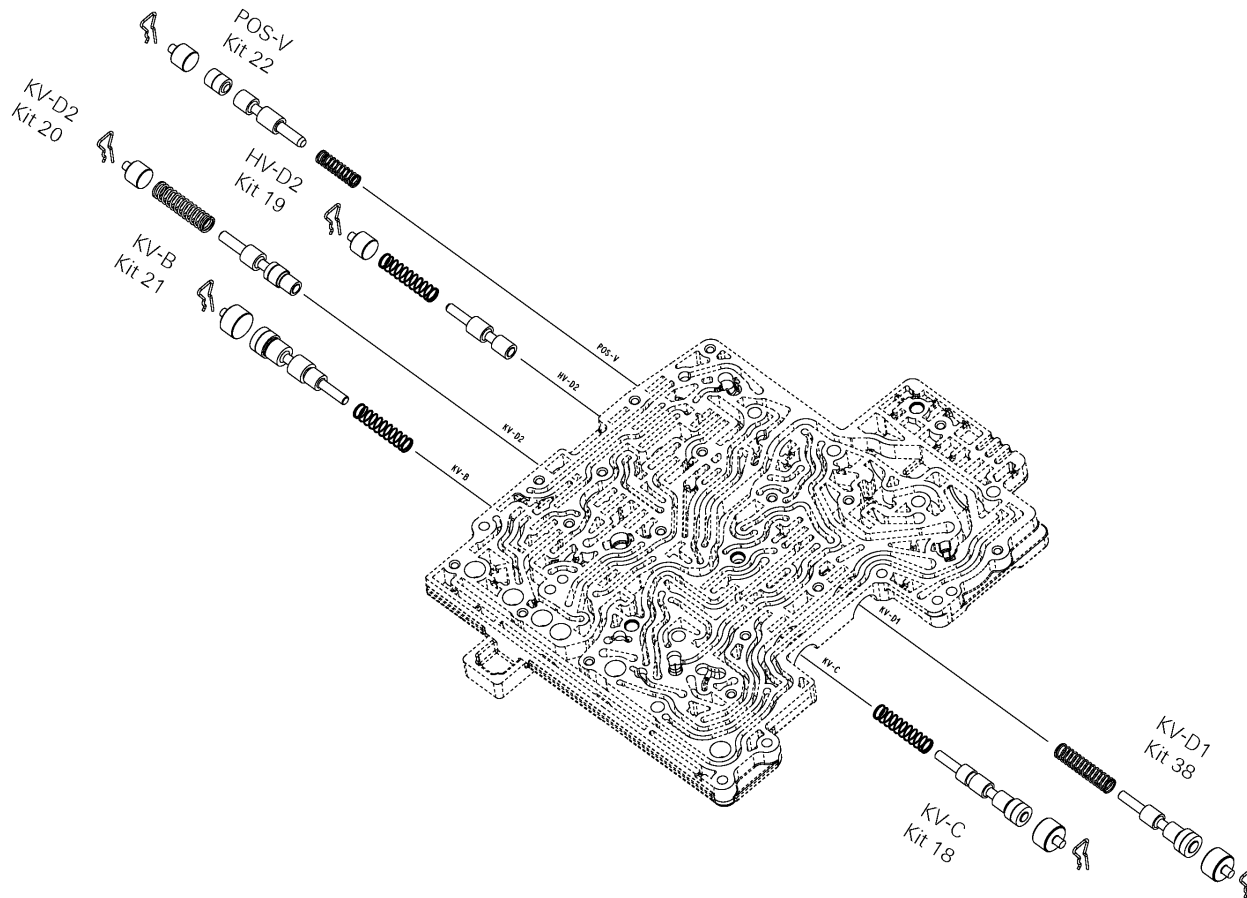

E20/2

Picture

Page 4 from 6

Material number: 1068.010.026

Picture: 1068_298_609-3

Material-assembly-group-no: 1068.298.043



6 HP 26 / ()
PRESSURE REGULATOR

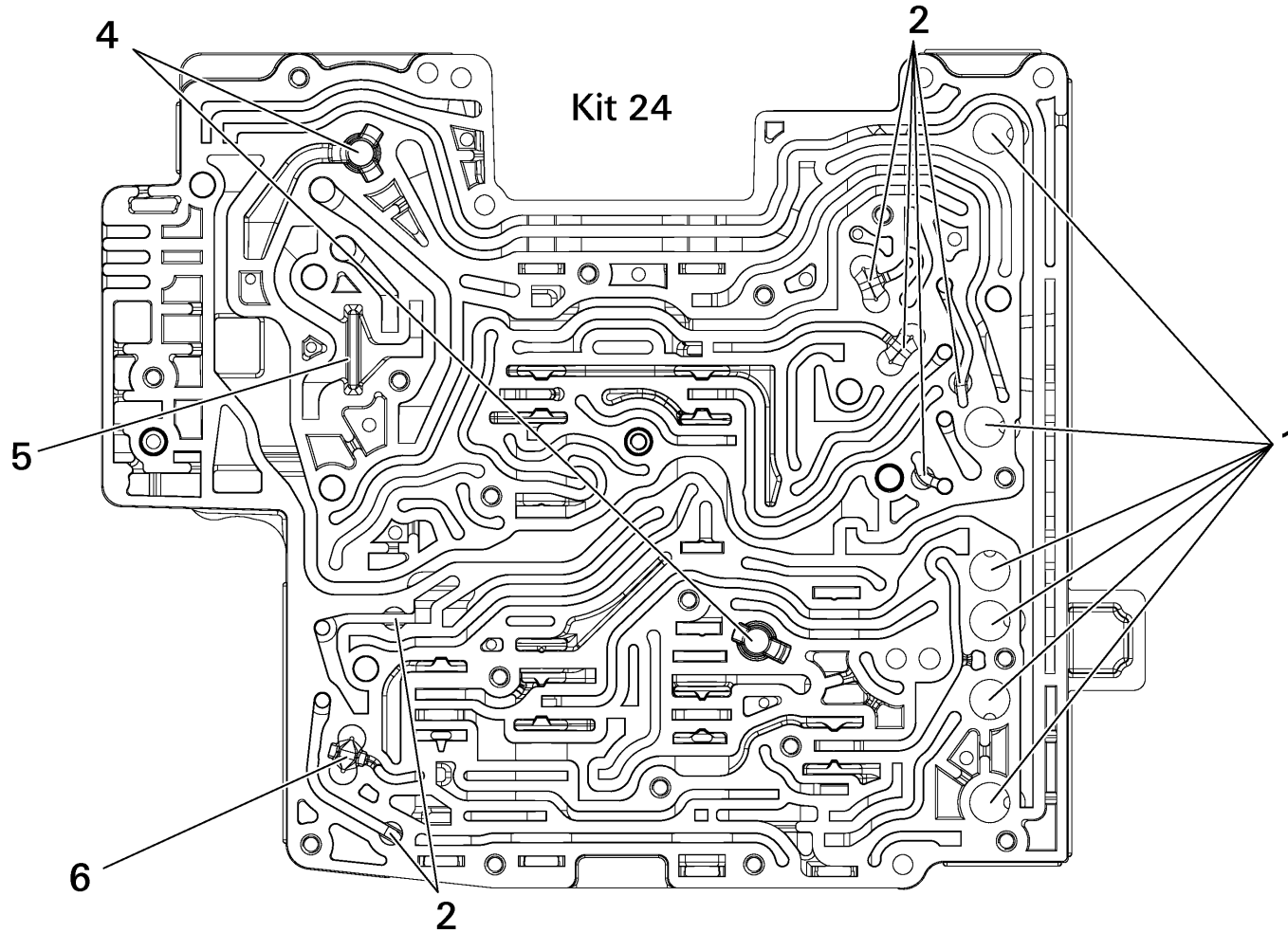

E20/2

Picture

Page 5 from 6

Material number: 1068.010.026

Picture: 1068_298_609-4

Material-assembly-group-no: 1068.298.043



6 HP 26 / ()
PRESSURE REGULATOR

1 - Kit 24

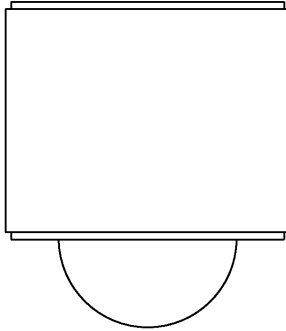

2 - Kit 24

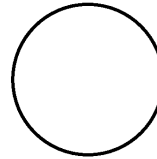

6 - Kit 24

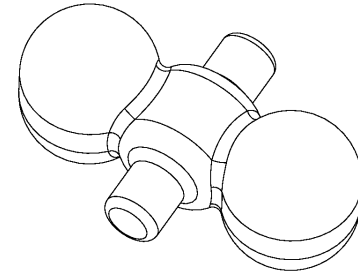

4 - Kit 24

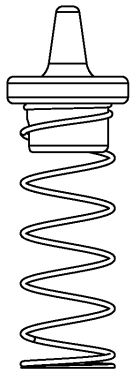

5 - Kit 24

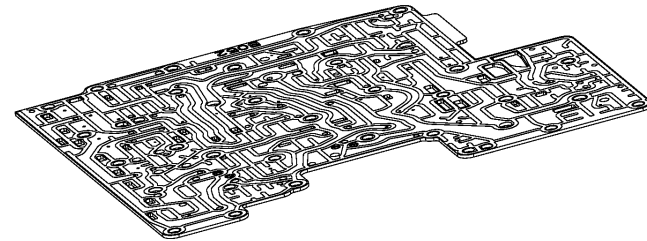
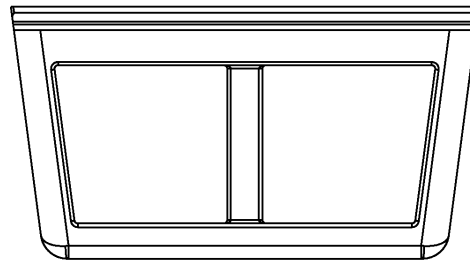

ET Zwischenblech

E20/2

Picture

Page 6 from 6

Material number: 1068.010.026

Picture: 114.D4.01-1

Material-assembly-group-no: 1068.298.043



6 HP 26 / ()
PRESSURE REGULATOR

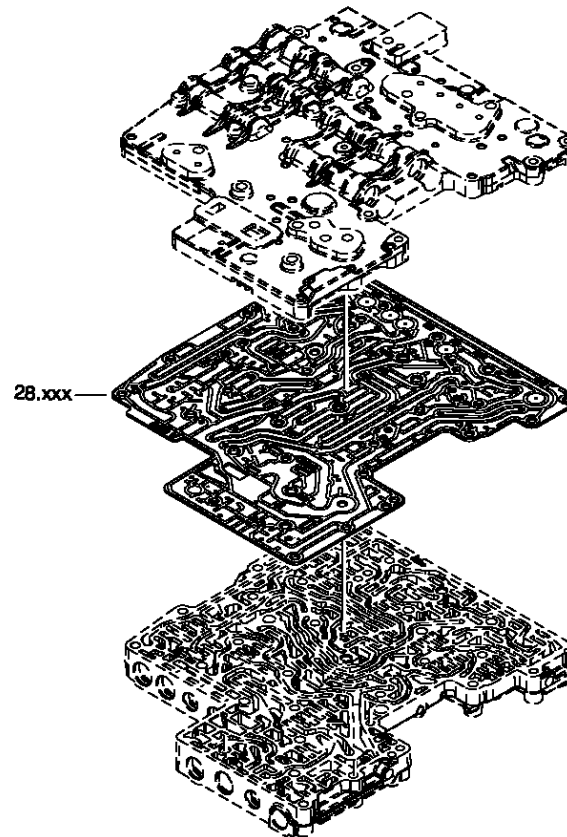

6 HP xx

Parts list

Page 1 from 1

Material number: 1068.010.026

Picture: 114.G6.01-1

Material-assembly-group-no: 1068.298.043



6 HP 26 / ()

	Pos.	Material number	Customer material	Name	Quantity	ME	Amend. no.	Techn. Info.	Rep kit	Alternative material
🛒	300	1068.298.043		PRESSURE REGULATOR	1			+MV-SATZ*E-SCH*6HP19*6HP26+X* 6HP32*NACH HSL BESTELLEN		

Picture

Page 1 from 1

Material number: 1068.010.026

Picture: 1068_298_103_X3

Material-assembly-group-no: 1068.298.103



6 HP 26 / ()
SEAL KIT

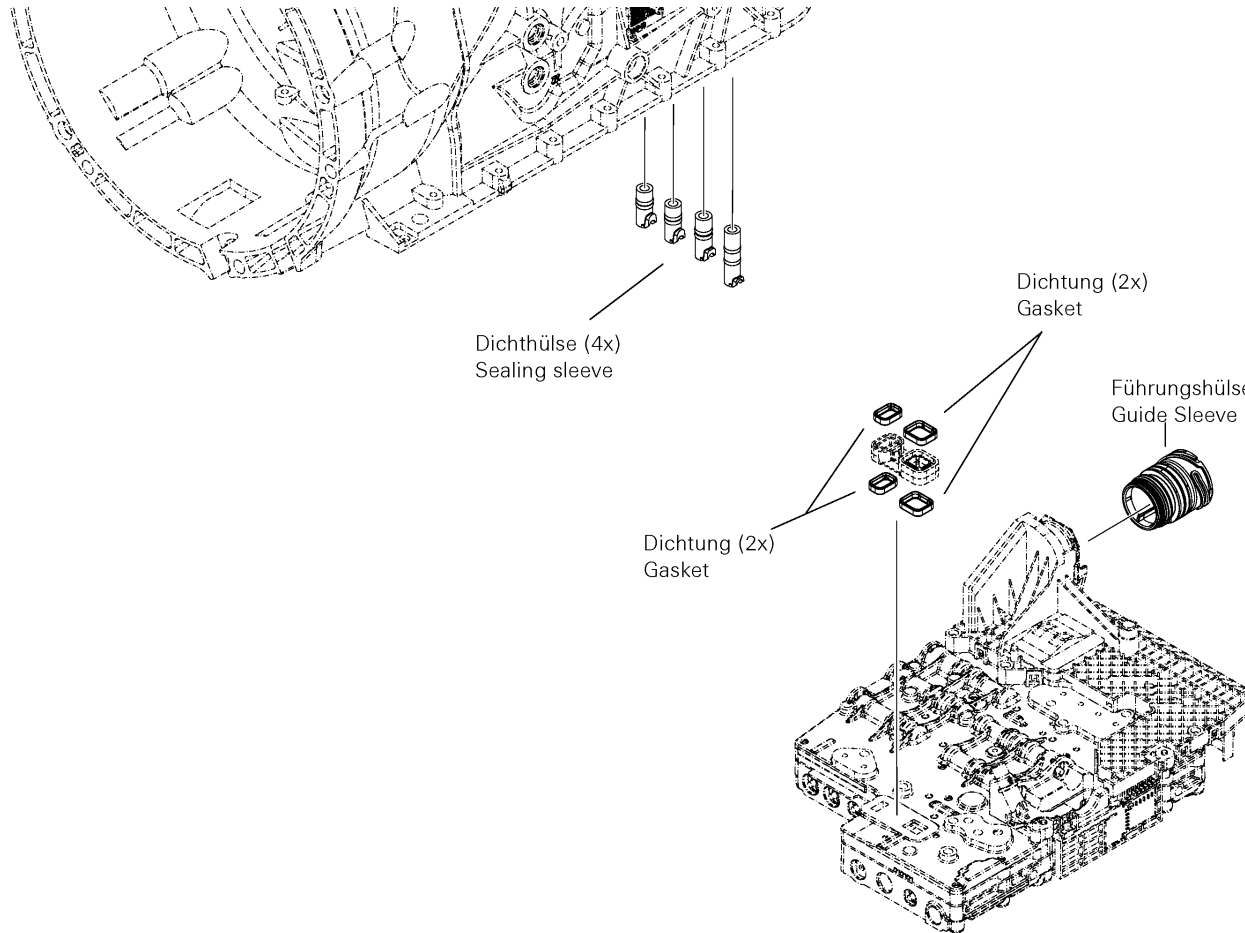

6HP26 /X
6HP28 /X

Parts list

Page 1 from 1

Material number: 1068.010.026

Picture: 1068_298_103_X3

Material-assembly-group-no: 1068.298.103



6 HP 26 / ()

	Pos.	Material number	Customer material	Name	Quantity	ME	Amend. no.	Techn. Info.	Rep kit	Alternative material
		1068.298.103		SEAL KIT	1			6HP26/X & 6HP28/X DICHTUNGEN FÜR MECHATRONIKTAUSCH		

Picture

Page 1 from 6

Material number: 1068.010.026

Picture: 1068_298_609-1

Material-assembly-group-no: 1068.298.501



6 HP 26 / ()
REPAIR KIT VALVE

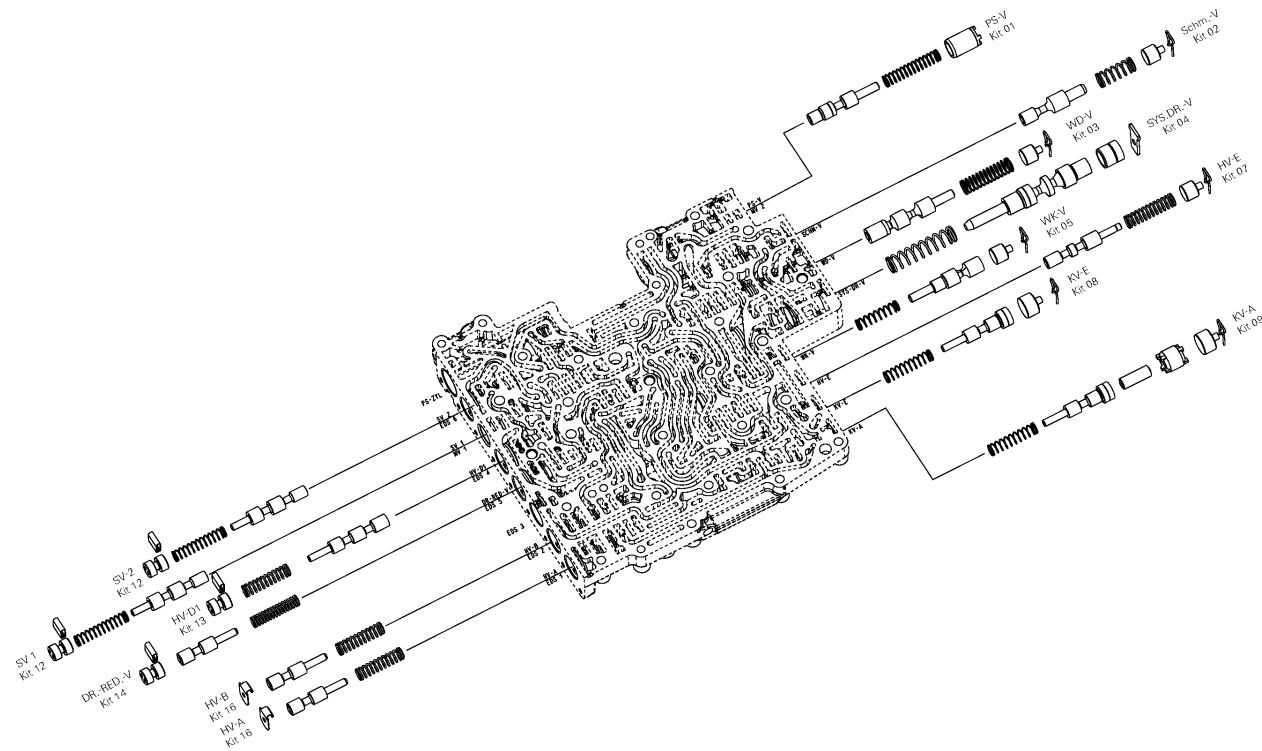

E20/2

Picture

Page 2 from 6

Material number: 1068.010.026

Picture: 1068_298_609-2

Material-assembly-group-no: 1068.298.501



6 HP 26 / ()
REPAIR KIT VALVE

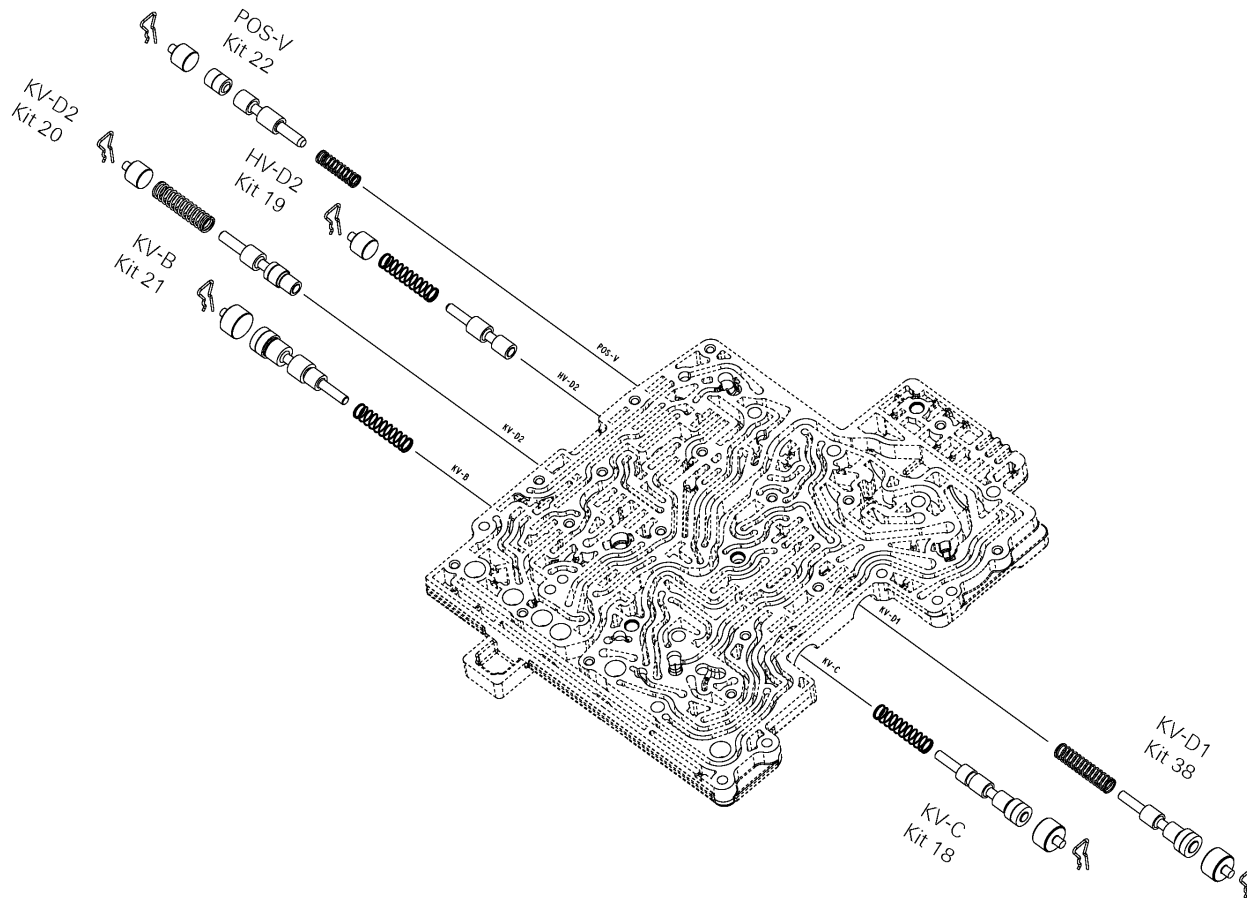

E20/2

Picture

Page 3 from 6

Material number: 1068.010.026

Picture: 1068_298_609-3

Material-assembly-group-no: 1068.298.501



6 HP 26 / ()
REPAIR KIT VALVE

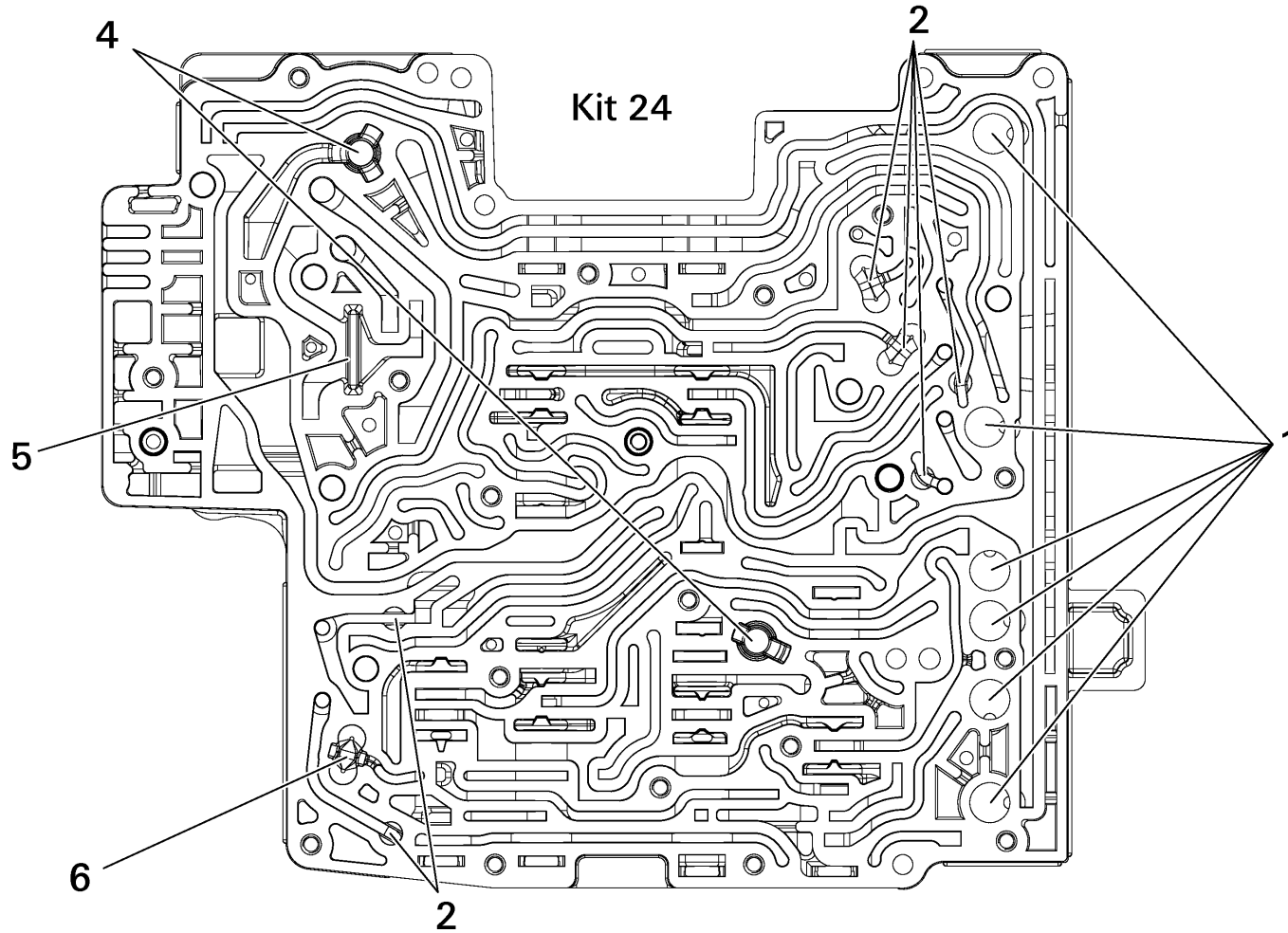

E20/2

Picture

Page 4 from 6

Material number: 1068.010.026

Picture: 1068_298_609-4

Material-assembly-group-no: 1068.298.501



6 HP 26 / ()
REPAIR KIT VALVE

1 - Kit 24

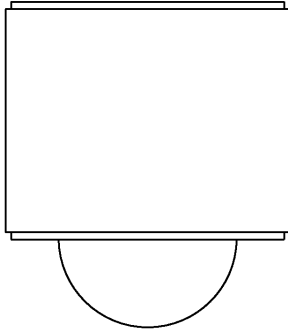

2 - Kit 24

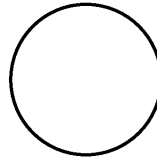

6 - Kit 24

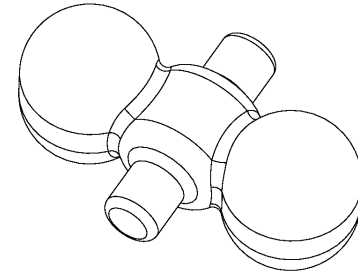

4 - Kit 24

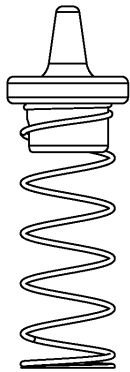

5 - Kit 24

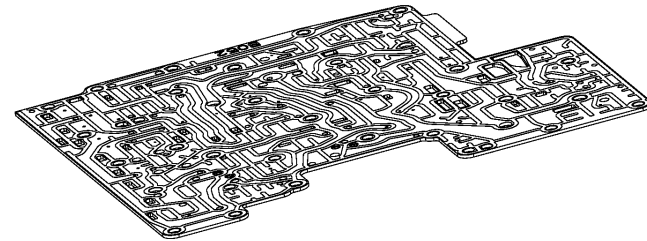
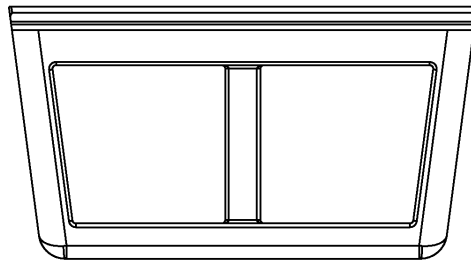

ET Zwischenblech

E20/2

Picture

Page 5 from 6

Material number: 1068.010.026

Picture: 114.D4.01-1

Material-assembly-group-no: 1068.298.501



6 HP 26 / ()
REPAIR KIT VALVE

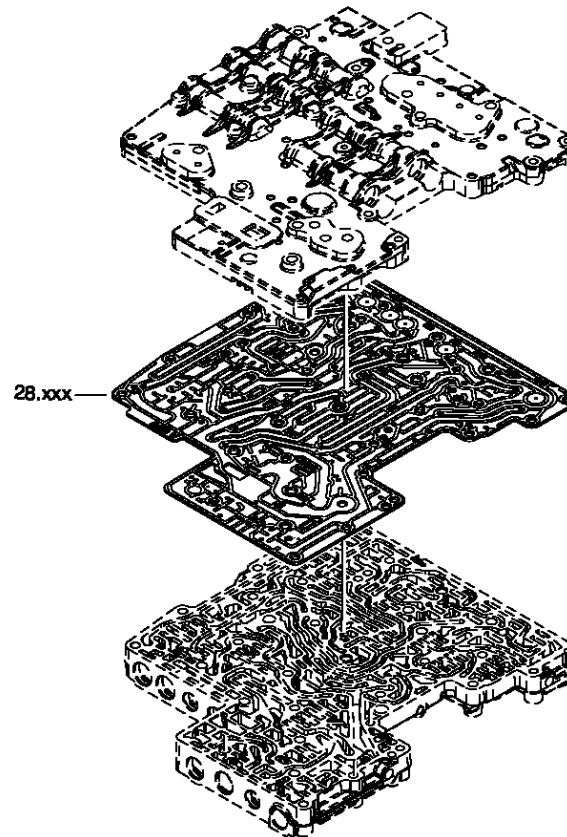

6 HP xx

Picture

Page 6 from 6

Material number: 1068.010.026

Picture: 114.G6.01-1

Material-assembly-group-no: 1068.298.501



6 HP 26 / ()
REPAIR KIT VALVE

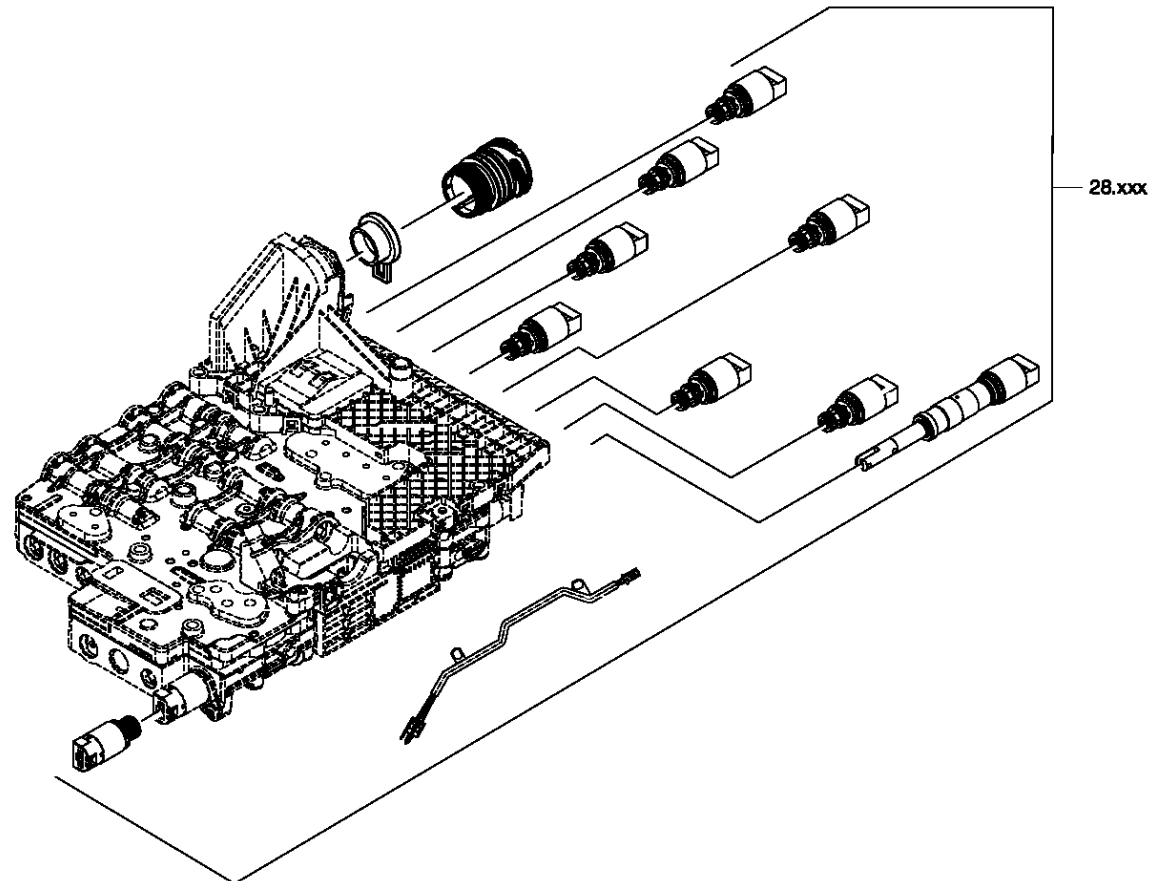

6 HP xx
E-Sch.

Parts list

Page 1 from 1

Material number: 1068.010.026

Picture: 1068_298_609-1

Material-assembly-group-no: 1068.298.501



6 HP 26 / ()

	Pos.	Material number	Customer material	Name	Quantity	ME	Amend. no.	Techn. Info.	Rep kit	Alternative material
🛒	300	1068.298.501		REPAIR KIT VALVE	1			(KIT 01) PS-V		

Picture

Page 1 from 6

Material number: 1068.010.026

Picture: 1068_298_609-1

Material-assembly-group-no: 1068.298.502



6 HP 26 / ()
REPAIR KIT VALVE

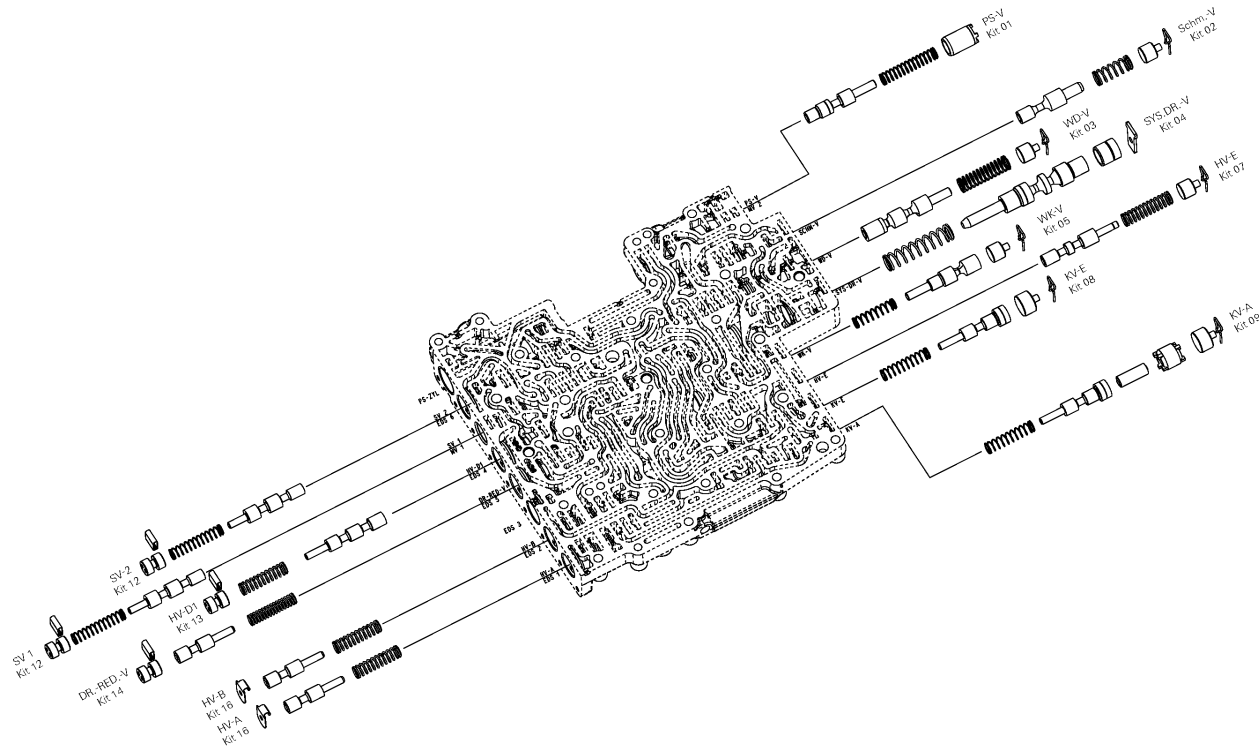

E20/2

Picture

Page 2 from 6

Material number: 1068.010.026

Picture: 1068_298_609-2

Material-assembly-group-no: 1068.298.502



6 HP 26 / ()
REPAIR KIT VALVE

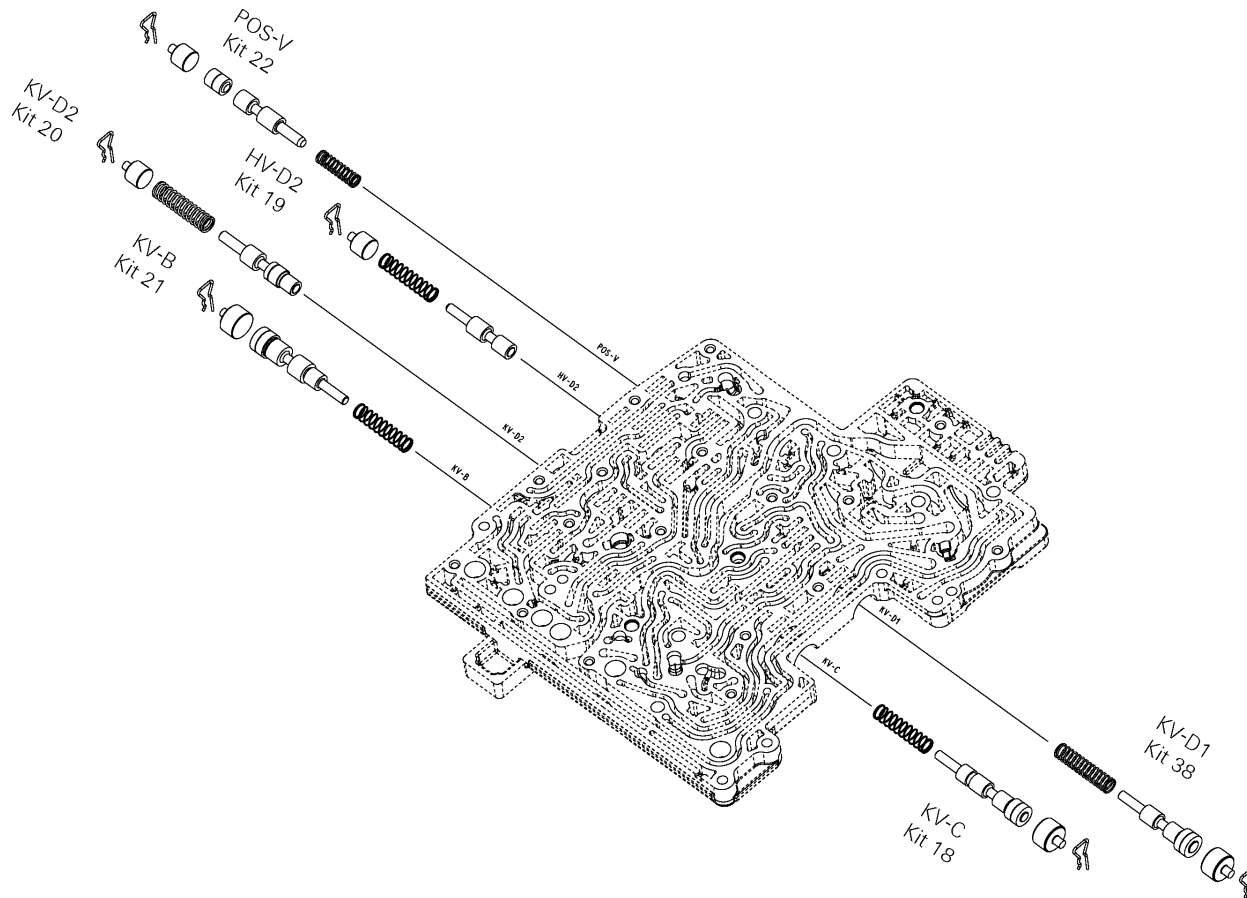

E20/2

Picture

Page 3 from 6

Material number: 1068.010.026

Picture: 1068_298_609-3

Material-assembly-group-no: 1068.298.502



6 HP 26 / ()
REPAIR KIT VALVE

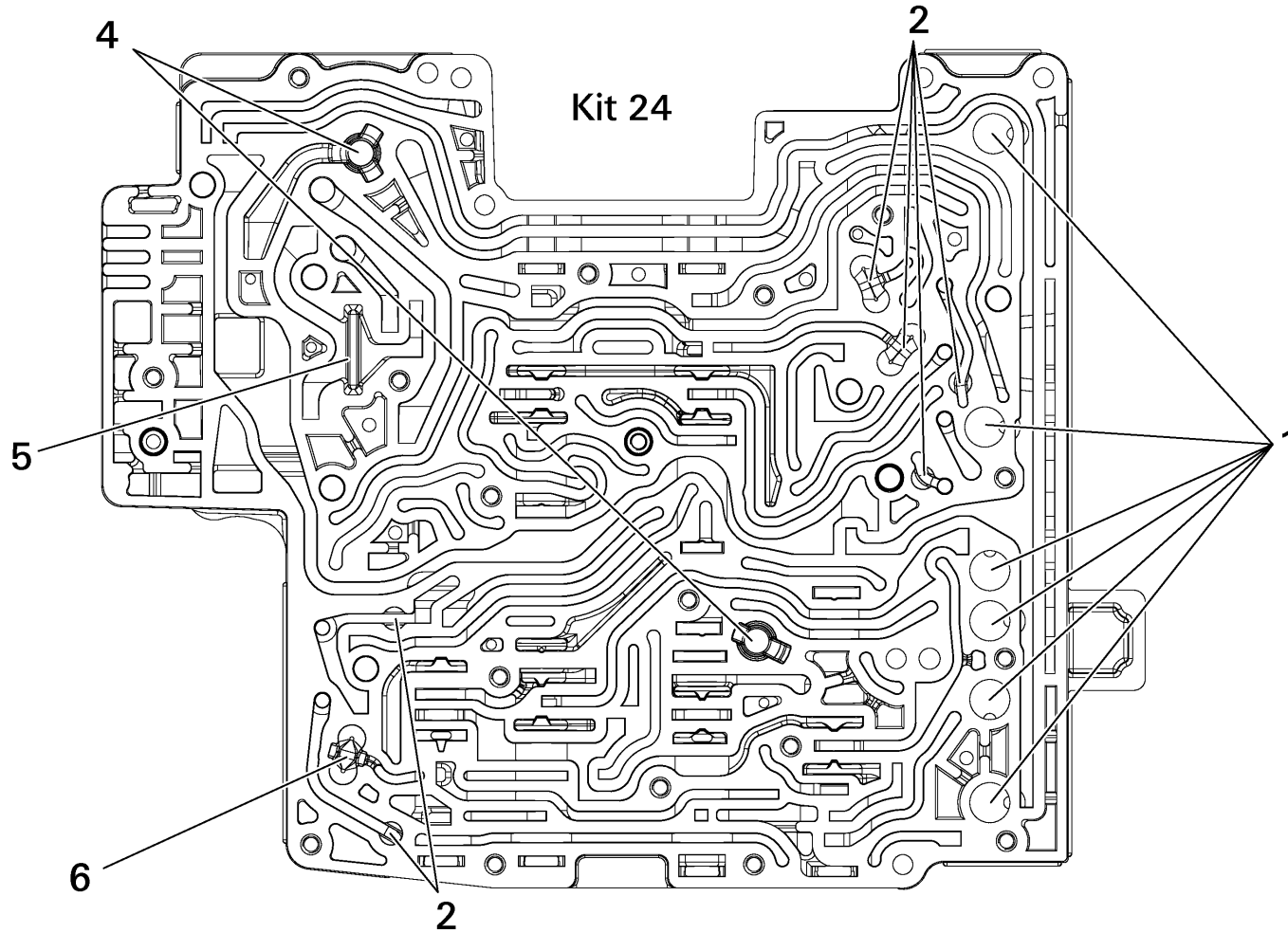

E20/2

Picture

Page 4 from 6

Material number: 1068.010.026

Picture: 1068_298_609-4

Material-assembly-group-no: 1068.298.502



6 HP 26 / ()
REPAIR KIT VALVE

1 - Kit 24

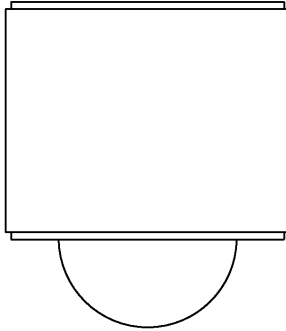

2 - Kit 24

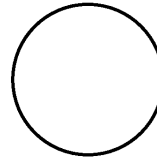

6 - Kit 24

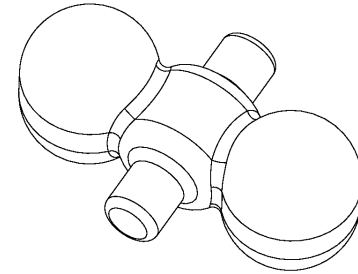

4 - Kit 24

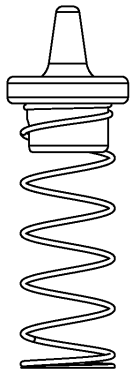

5 - Kit 24

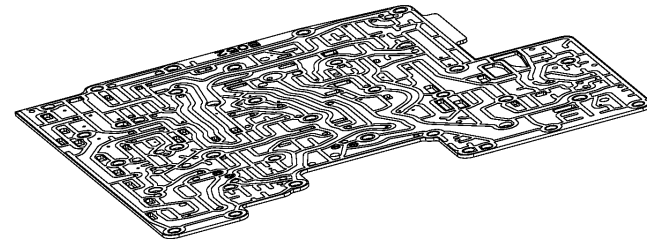
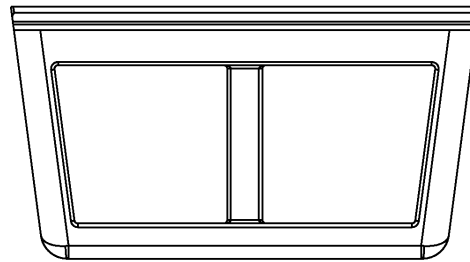

ET Zwischenblech

E20/2

Picture

Page 5 from 6

Material number: 1068.010.026

Picture: 114.D4.01-1

Material-assembly-group-no: 1068.298.502



6 HP 26 / ()
REPAIR KIT VALVE

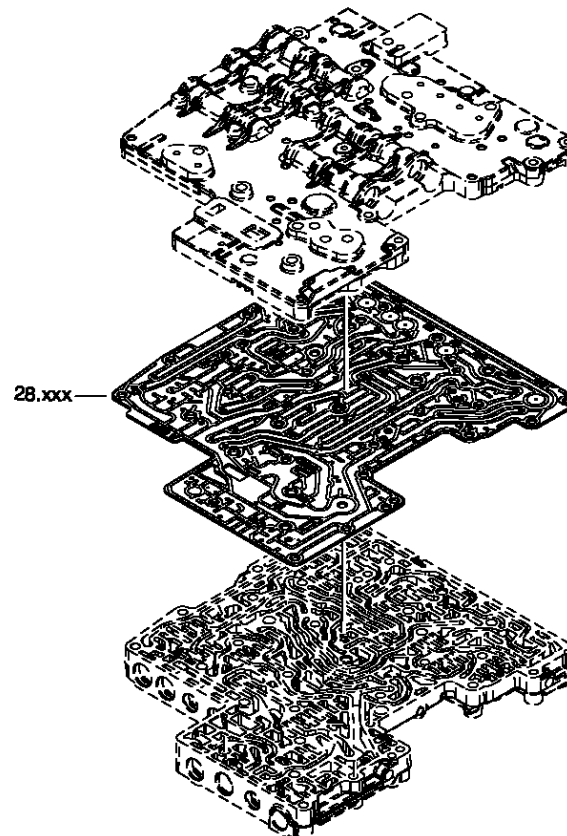

6 HP xx

Picture

Page 6 from 6

Material number: 1068.010.026

Picture: 114.G6.01-1

Material-assembly-group-no: 1068.298.502



6 HP 26 / ()
REPAIR KIT VALVE

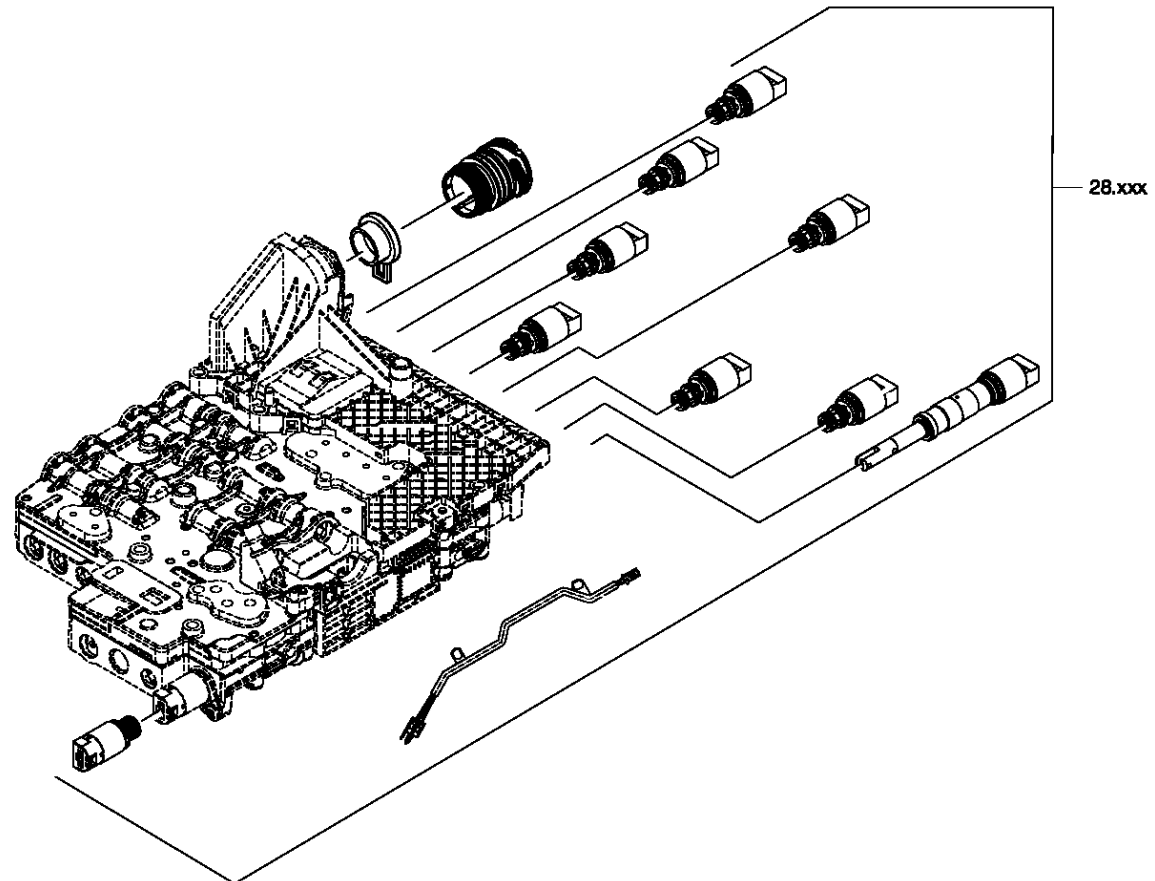

6 HP xx
E-Sch.

Picture

Page 1 from 6

Material number: 1068.010.026

Picture: 1068_298_609-1

Material-assembly-group-no: 1068.298.503



6 HP 26 / ()
REPAIR KIT VALVE

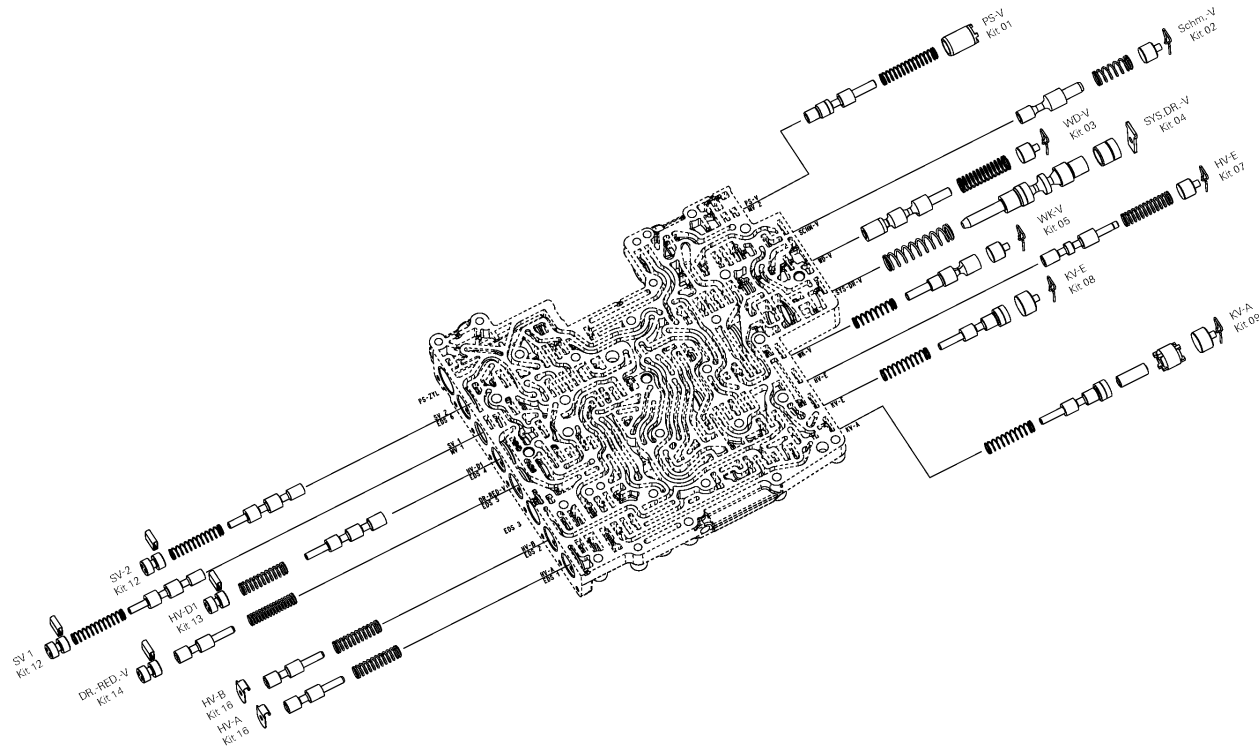

E20/2

Picture

Page 2 from 6

Material number: 1068.010.026

Picture: 1068_298_609-2

Material-assembly-group-no: 1068.298.503



6 HP 26 / ()
REPAIR KIT VALVE

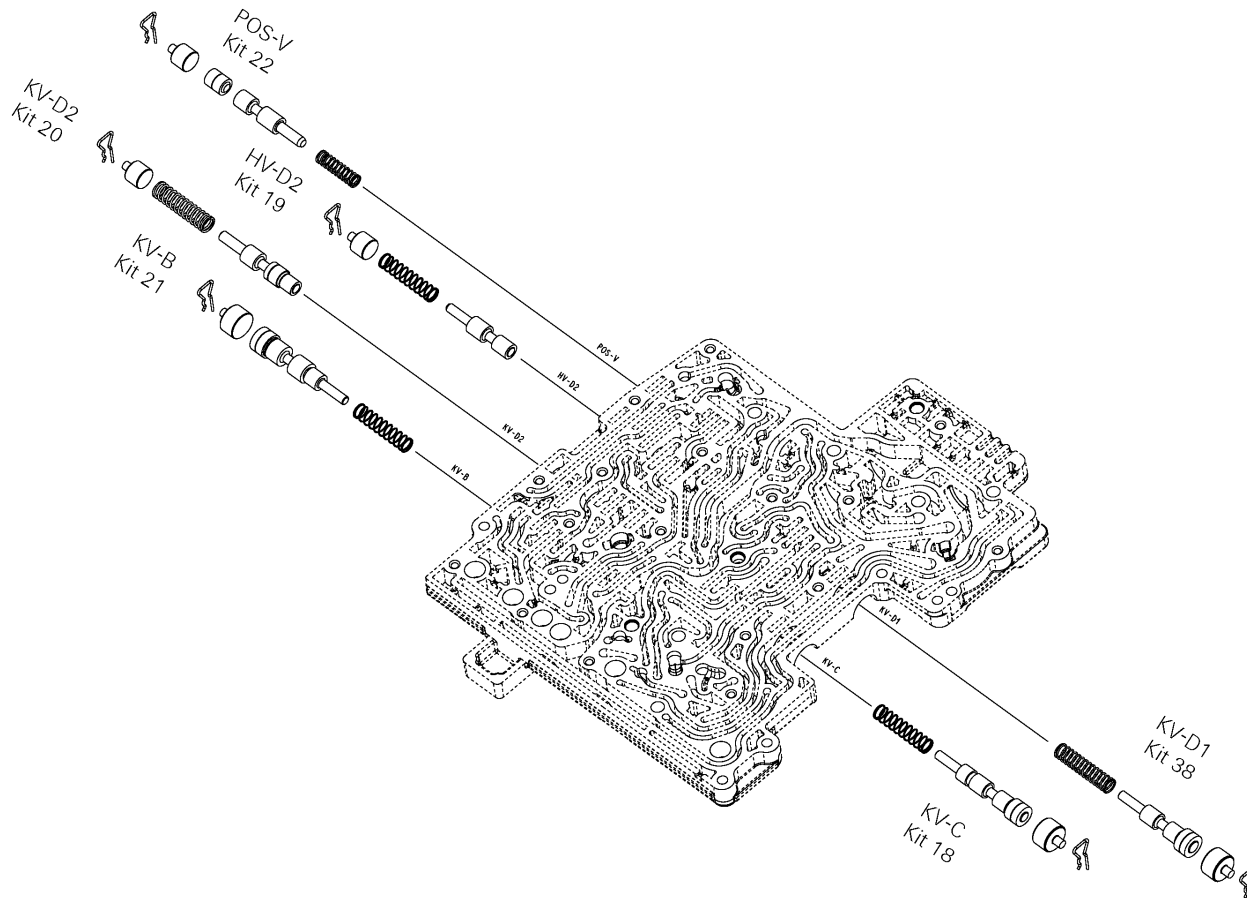

E20/2

Picture

Page 3 from 6

Material number: 1068.010.026

Picture: 1068_298_609-3

Material-assembly-group-no: 1068.298.503



6 HP 26 / ()
REPAIR KIT VALVE

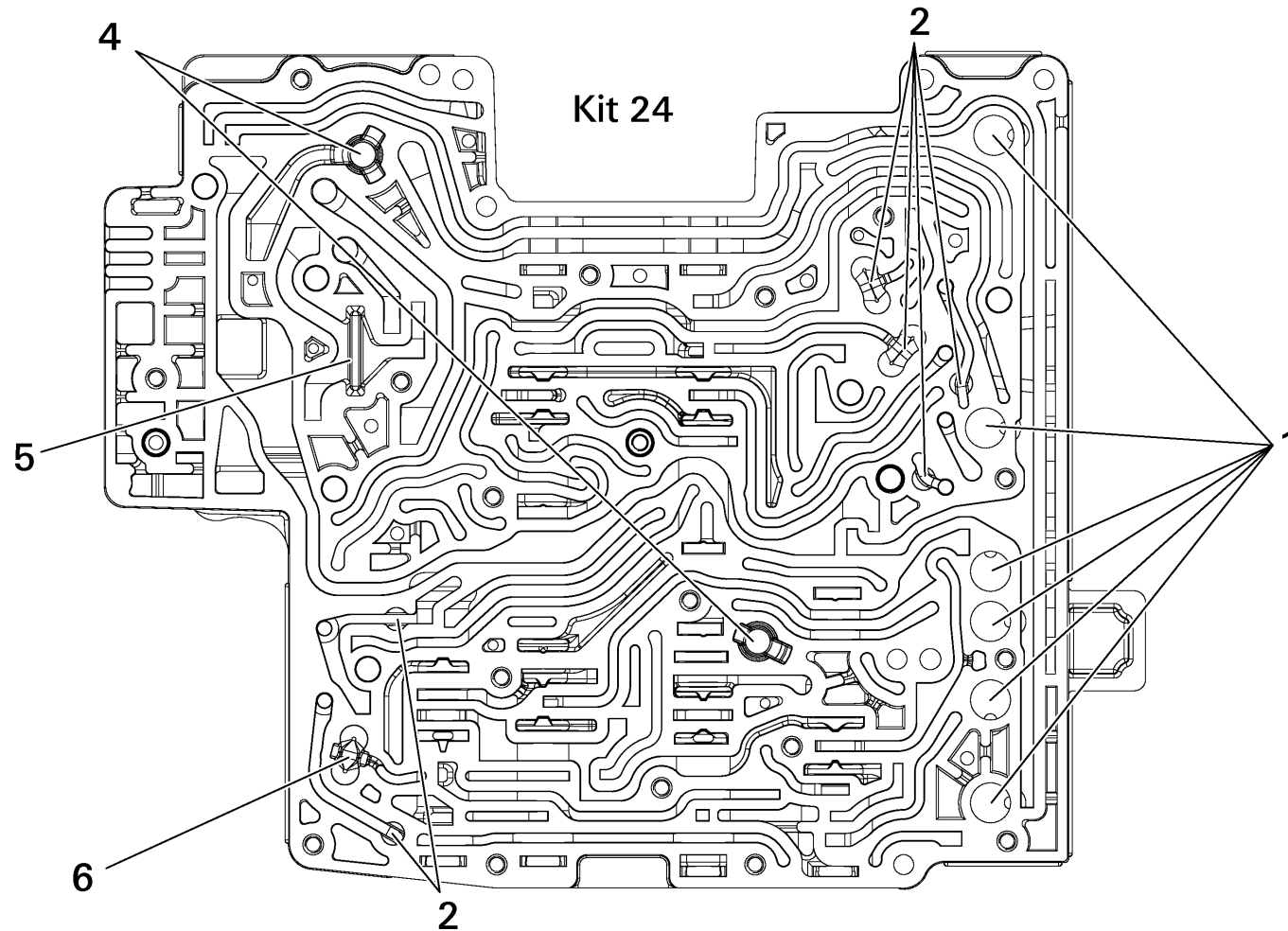

E20/2

Picture

Page 4 from 6

Material number: 1068.010.026

Picture: 1068_298_609-4

Material-assembly-group-no: 1068.298.503



6 HP 26 / ()
REPAIR KIT VALVE

1 - Kit 24

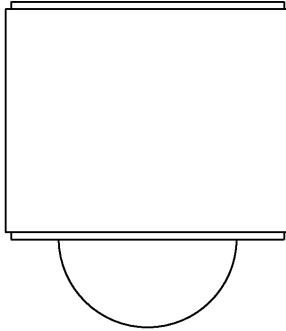

2 - Kit 24

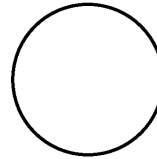

6 - Kit 24

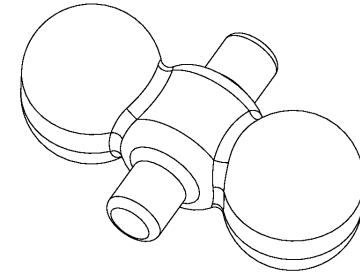

4 - Kit 24

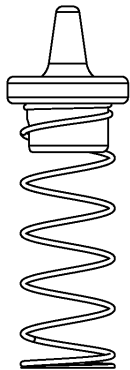

5 - Kit 24

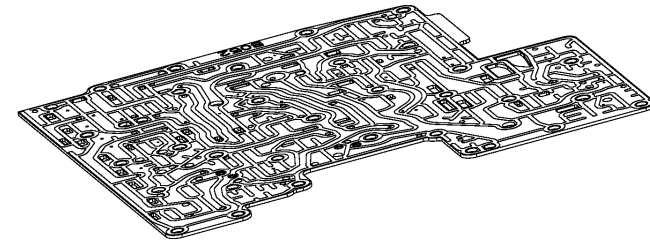
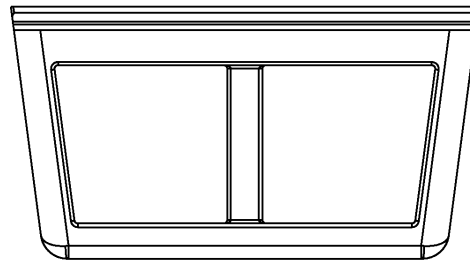

ET Zwischenblech

E20/2

Picture

Page 5 from 6

Material number: 1068.010.026

Picture: 114.D4.01-1

Material-assembly-group-no: 1068.298.503



6 HP 26 / ()
REPAIR KIT VALVE

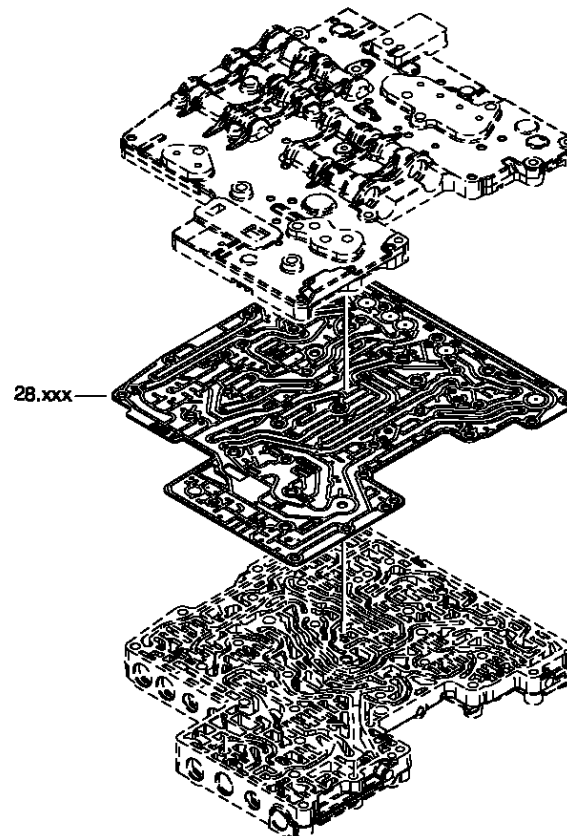

6 HP xx

Picture

Page 6 from 6

Material number: 1068.010.026

Picture: 114.G6.01-1

Material-assembly-group-no: 1068.298.503



6 HP 26 / ()
REPAIR KIT VALVE

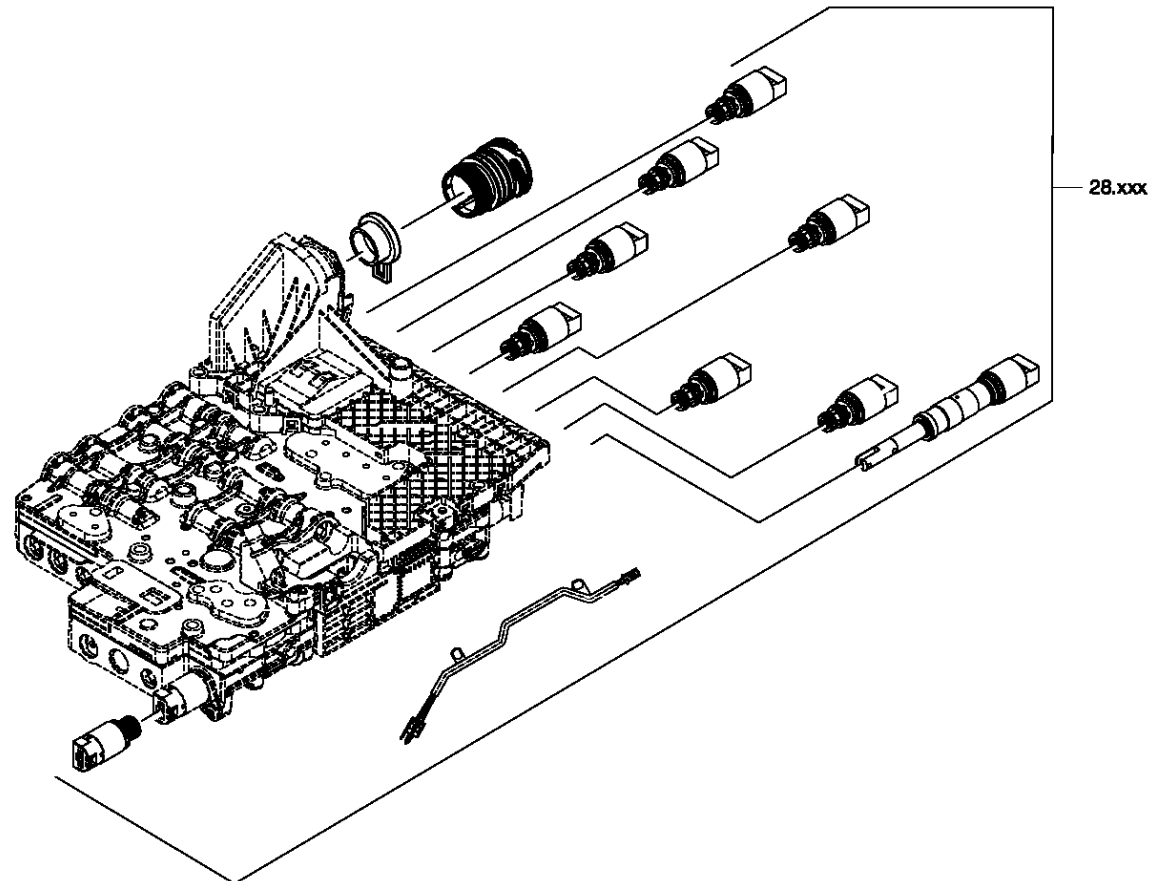

6 HP xx
E-Sch.

Picture

Page 1 from 6

Material number: 1068.010.026

Picture: 1068_298_609-1

Material-assembly-group-no: 1068.298.504



6 HP 26 / ()
REPAIR KIT VALVE

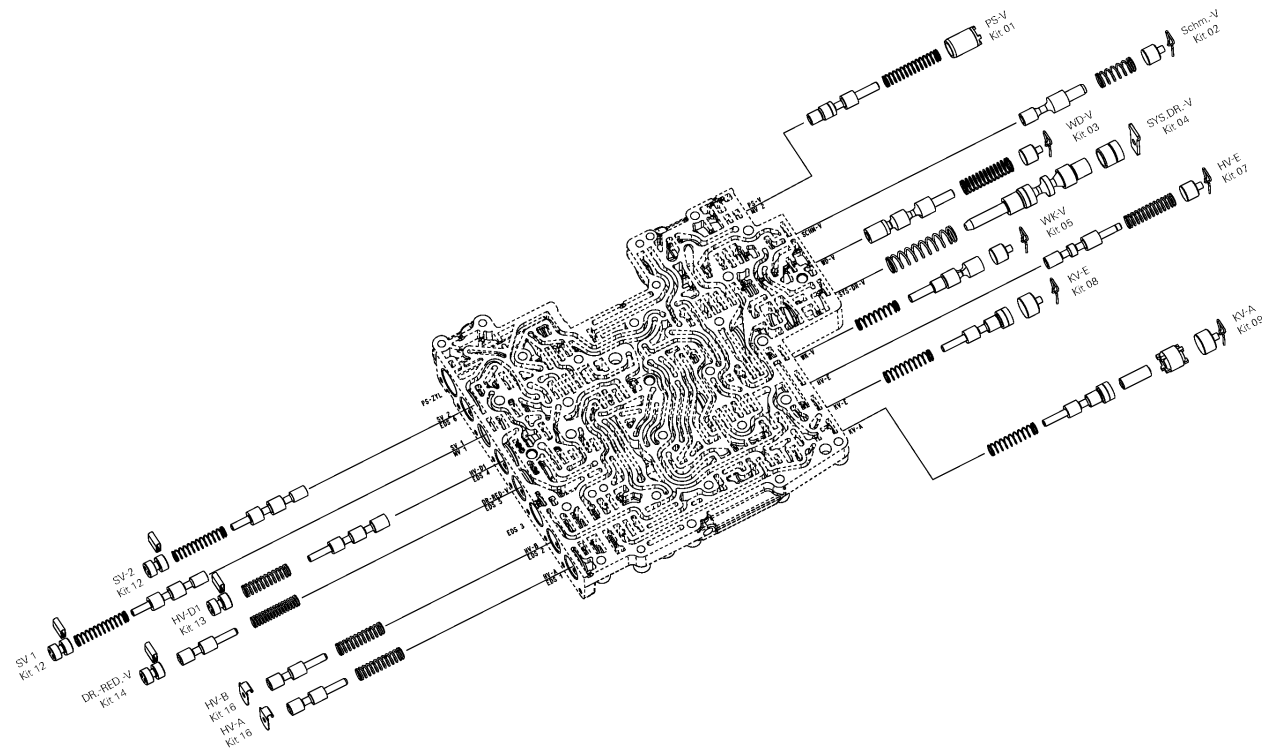

E20/2

Picture

Page 2 from 6

Material number: 1068.010.026

Picture: 1068_298_609-2

Material-assembly-group-no: 1068.298.504



6 HP 26 / ()
REPAIR KIT VALVE

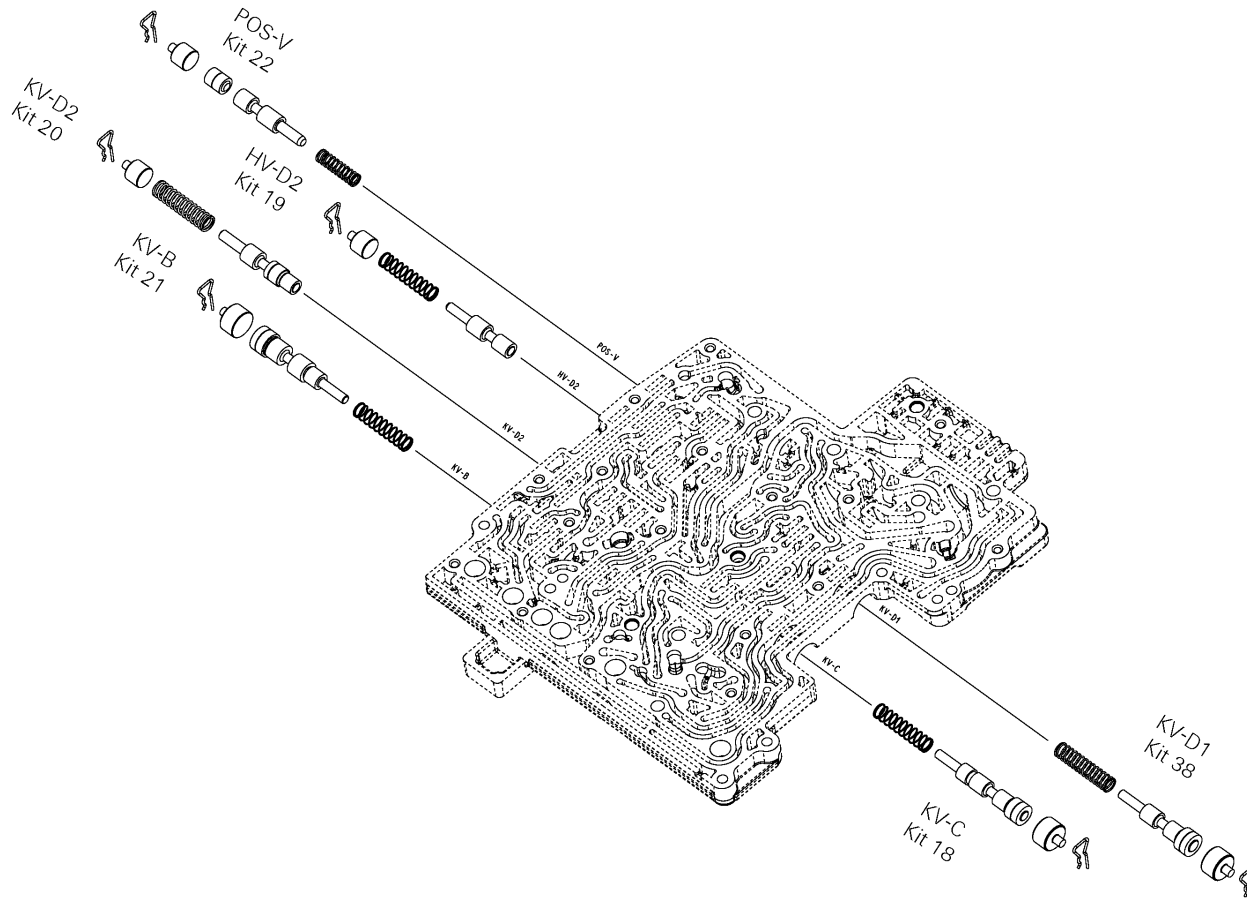

E20/2

Picture

Page 3 from 6

Material number: 1068.010.026

Picture: 1068_298_609-3

Material-assembly-group-no: 1068.298.504



6 HP 26 / ()
REPAIR KIT VALVE

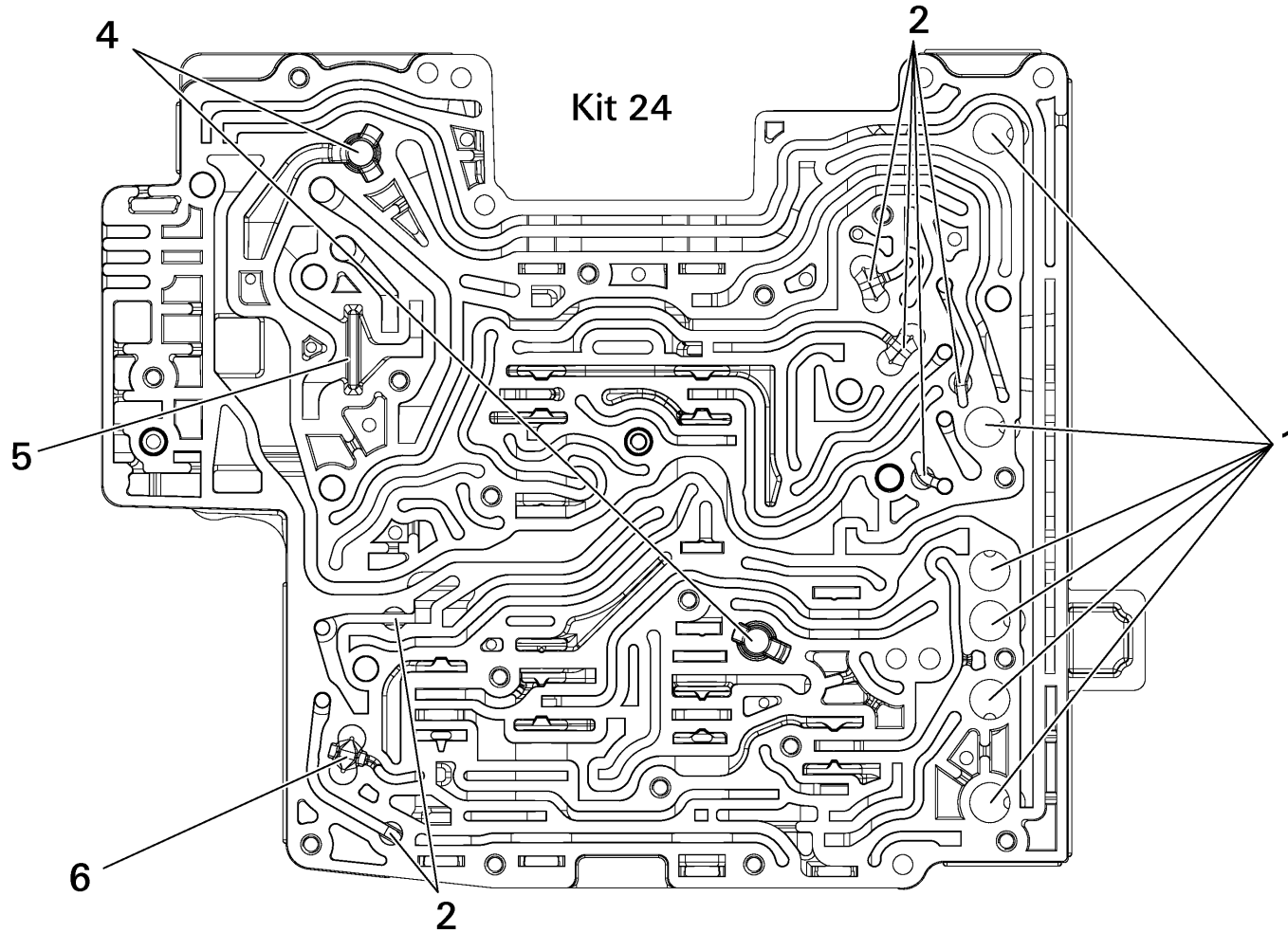

E20/2

Picture

Page 4 from 6

Material number: 1068.010.026

Picture: 1068_298_609-4

Material-assembly-group-no: 1068.298.504



6 HP 26 / ()
REPAIR KIT VALVE

1 - Kit 24

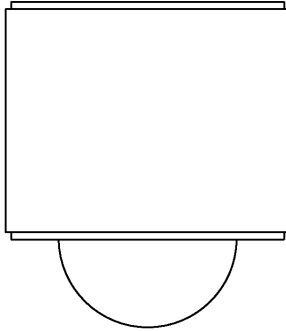

2 - Kit 24

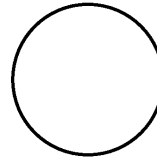

6 - Kit 24

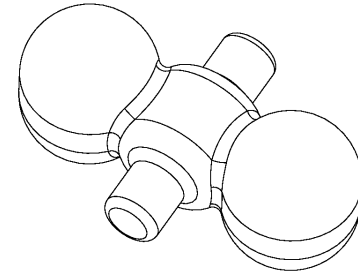

4 - Kit 24

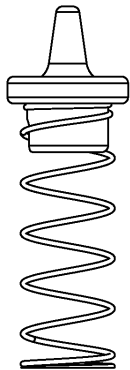

5 - Kit 24

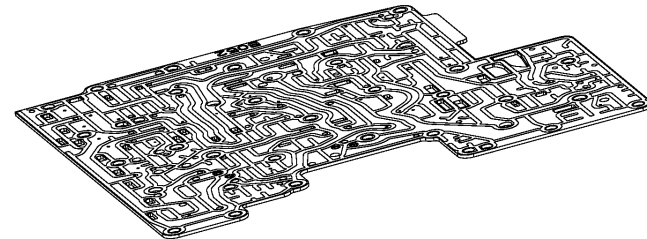
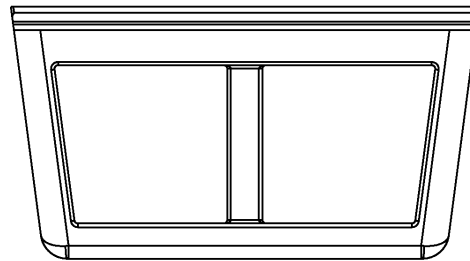

ET Zwischenblech

E20/2

Picture

Page 5 from 6

Material number: 1068.010.026

Picture: 114.D4.01-1

Material-assembly-group-no: 1068.298.504



6 HP 26 / ()
REPAIR KIT VALVE

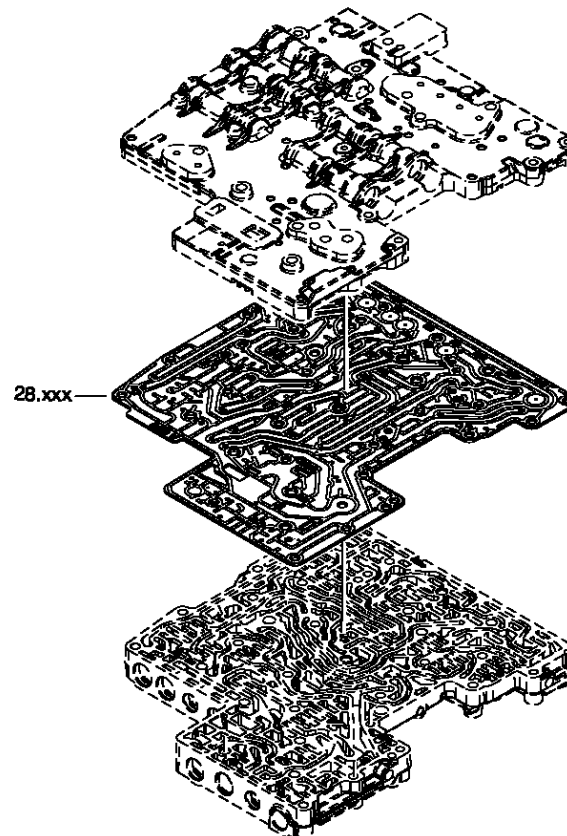

6 HP xx

Picture

Page 6 from 6

Material number: 1068.010.026

Picture: 114.G6.01-1

Material-assembly-group-no: 1068.298.504



6 HP 26 / ()
REPAIR KIT VALVE

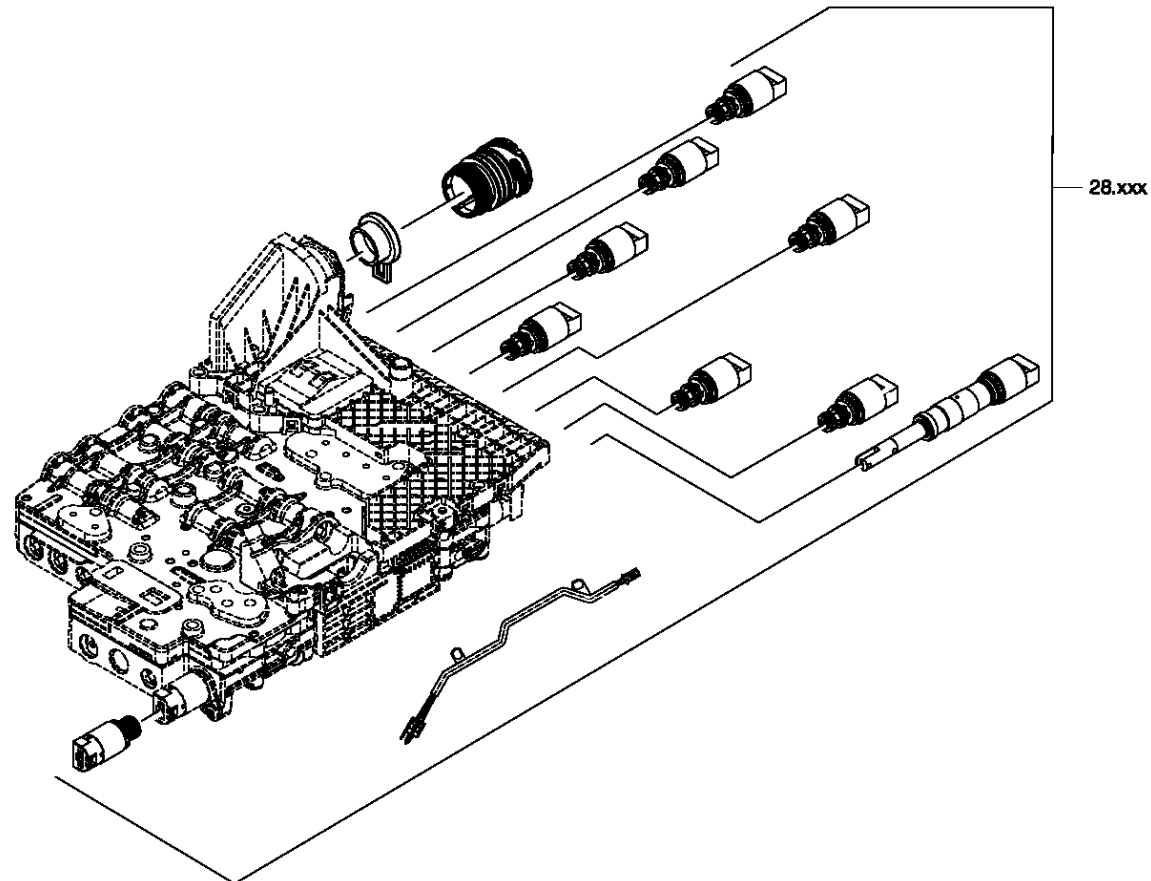

6 HP xx
E-Sch.

Picture

Page 1 from 6

Material number: 1068.010.026

Picture: 1068_298_609-1

Material-assembly-group-no: 1068.298.505



6 HP 26 / ()
REPAIR KIT VALVE

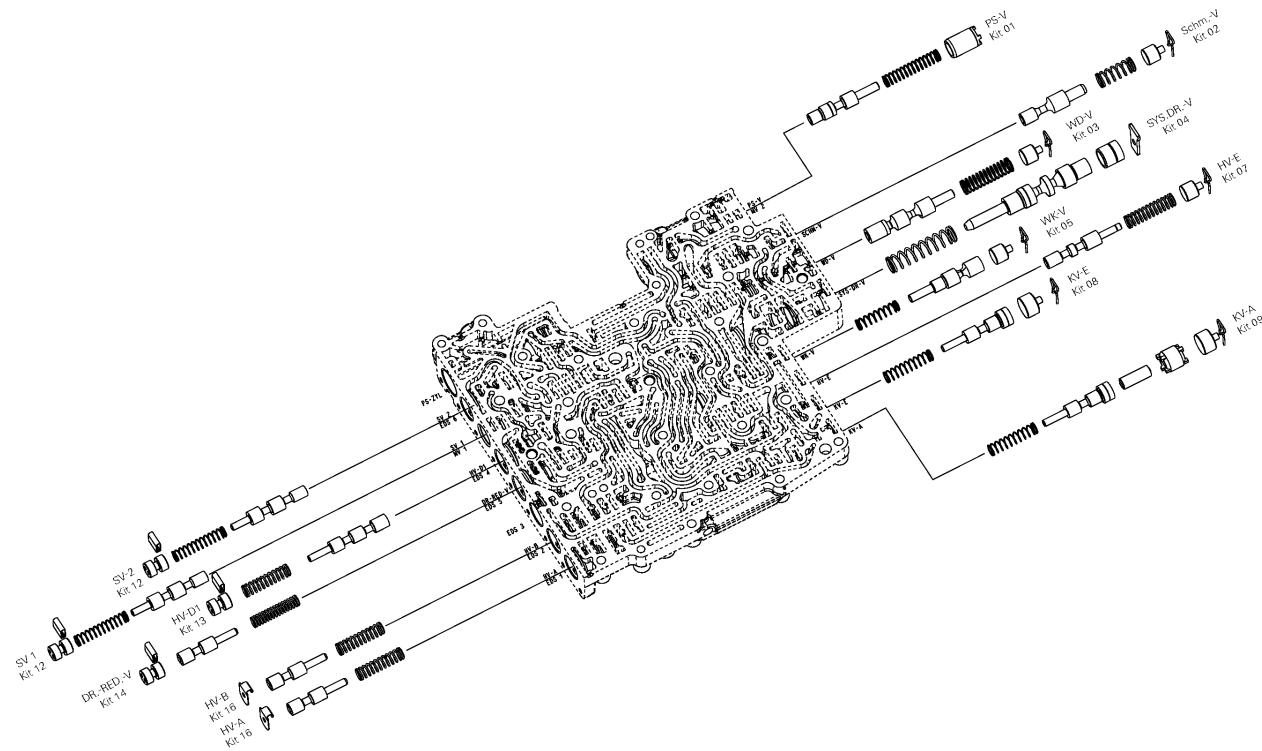

E20/2

Picture

Page 2 from 6

Material number: 1068.010.026

Picture: 1068_298_609-2

Material-assembly-group-no: 1068.298.505



6 HP 26 / ()
REPAIR KIT VALVE

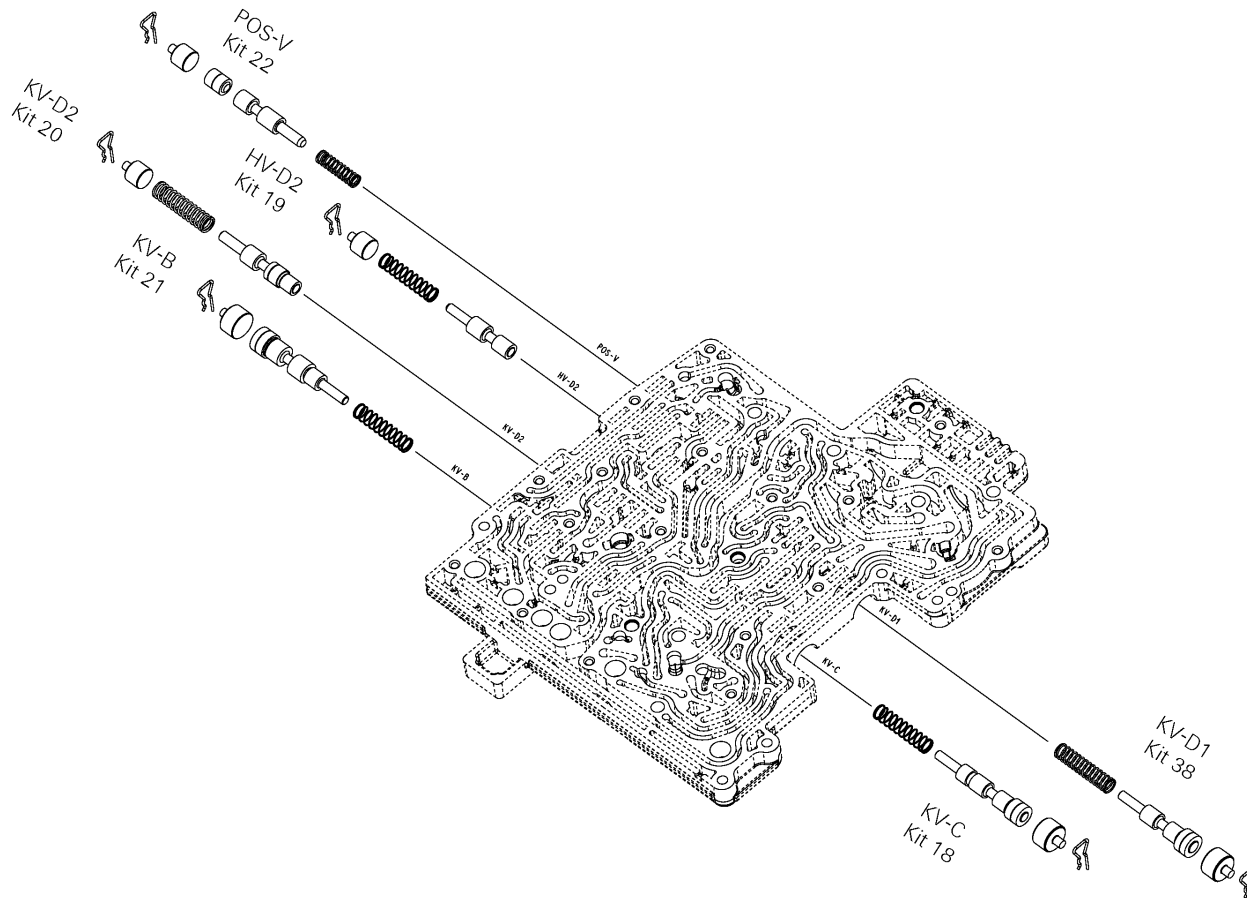

E20/2

Picture

Page 3 from 6

Material number: 1068.010.026

Picture: 1068_298_609-3

Material-assembly-group-no: 1068.298.505



6 HP 26 / ()
REPAIR KIT VALVE

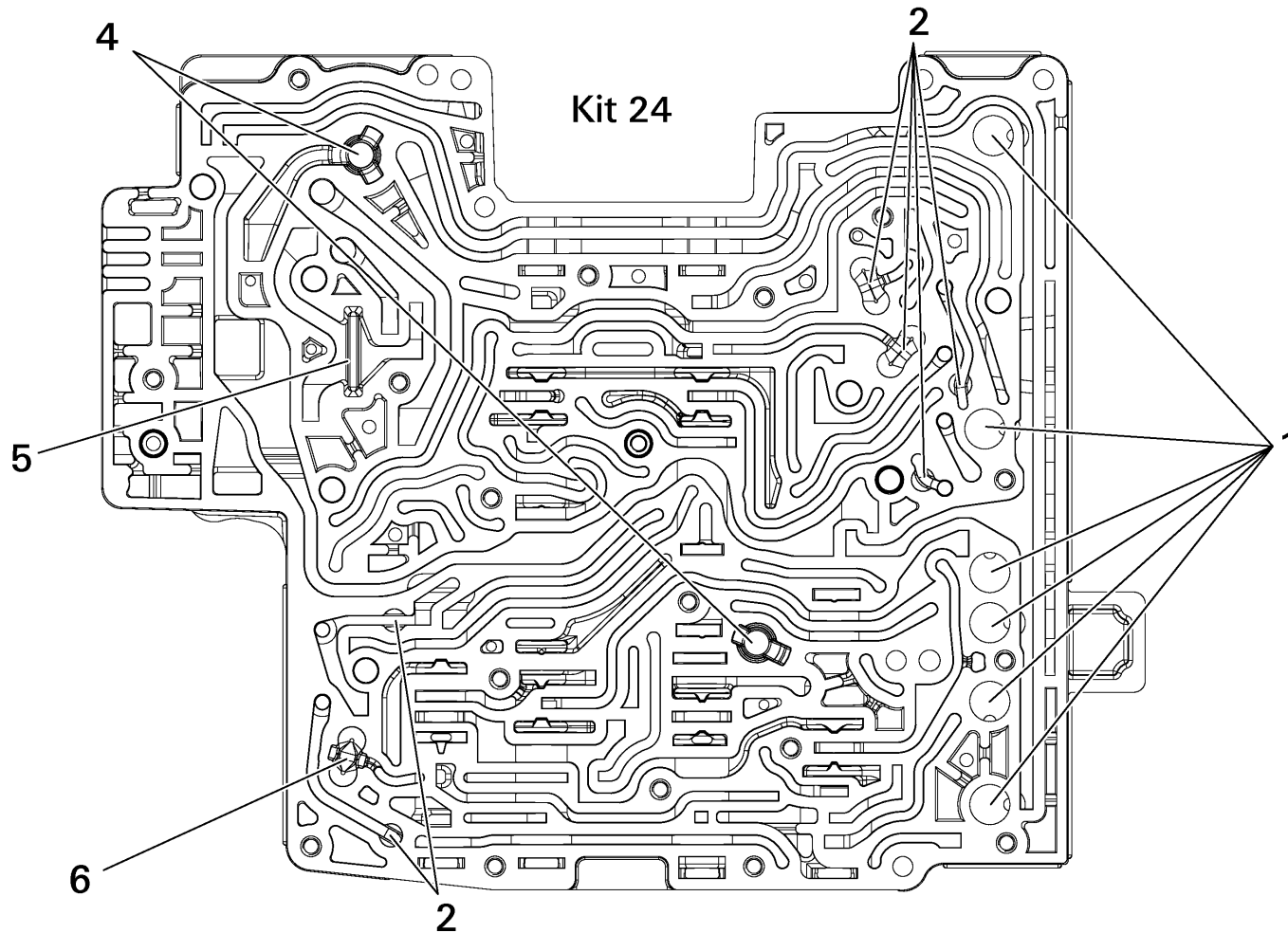

E20/2

Picture

Page 4 from 6

Material number: 1068.010.026

Picture: 1068_298_609-4

Material-assembly-group-no: 1068.298.505



6 HP 26 / ()
REPAIR KIT VALVE

1 - Kit 24

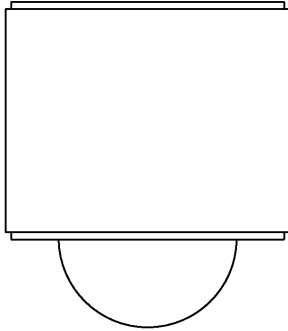

2 - Kit 24

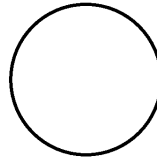

6 - Kit 24

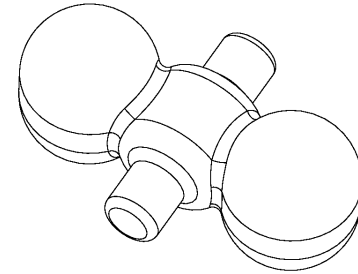

4 - Kit 24

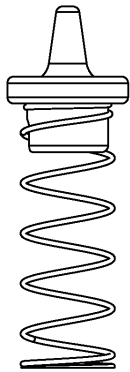

5 - Kit 24

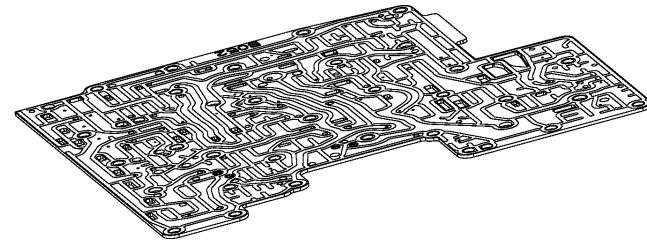
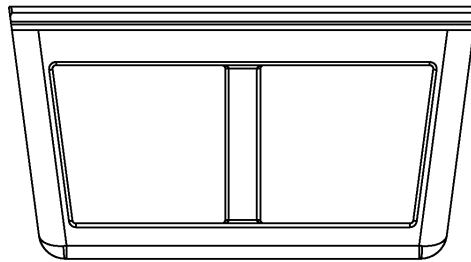

ET Zwischenblech

E20/2

Picture

Page 5 from 6

Material number: 1068.010.026

Picture: 114.D4.01-1

Material-assembly-group-no: 1068.298.505



6 HP 26 / ()
REPAIR KIT VALVE

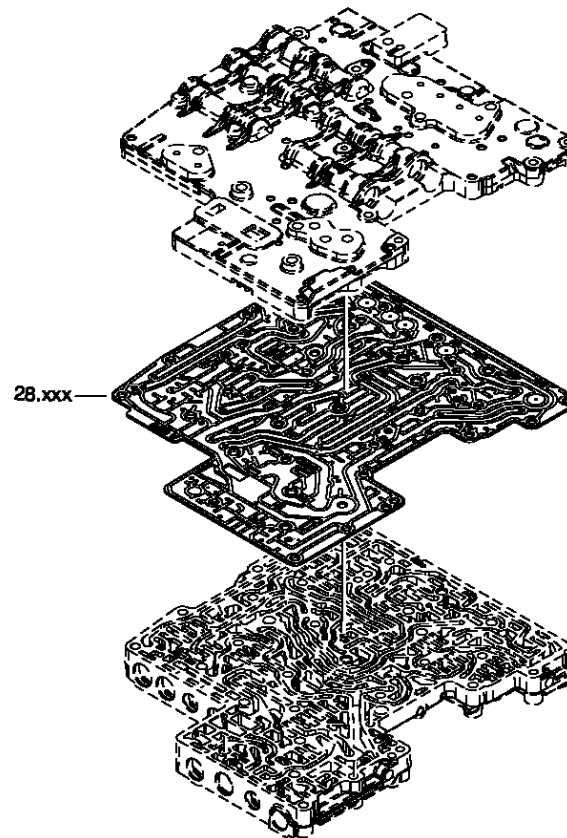

6 HP xx

Picture

Page 6 from 6

Material number: 1068.010.026

Picture: 114.G6.01-1

Material-assembly-group-no: 1068.298.505



6 HP 26 / ()
REPAIR KIT VALVE

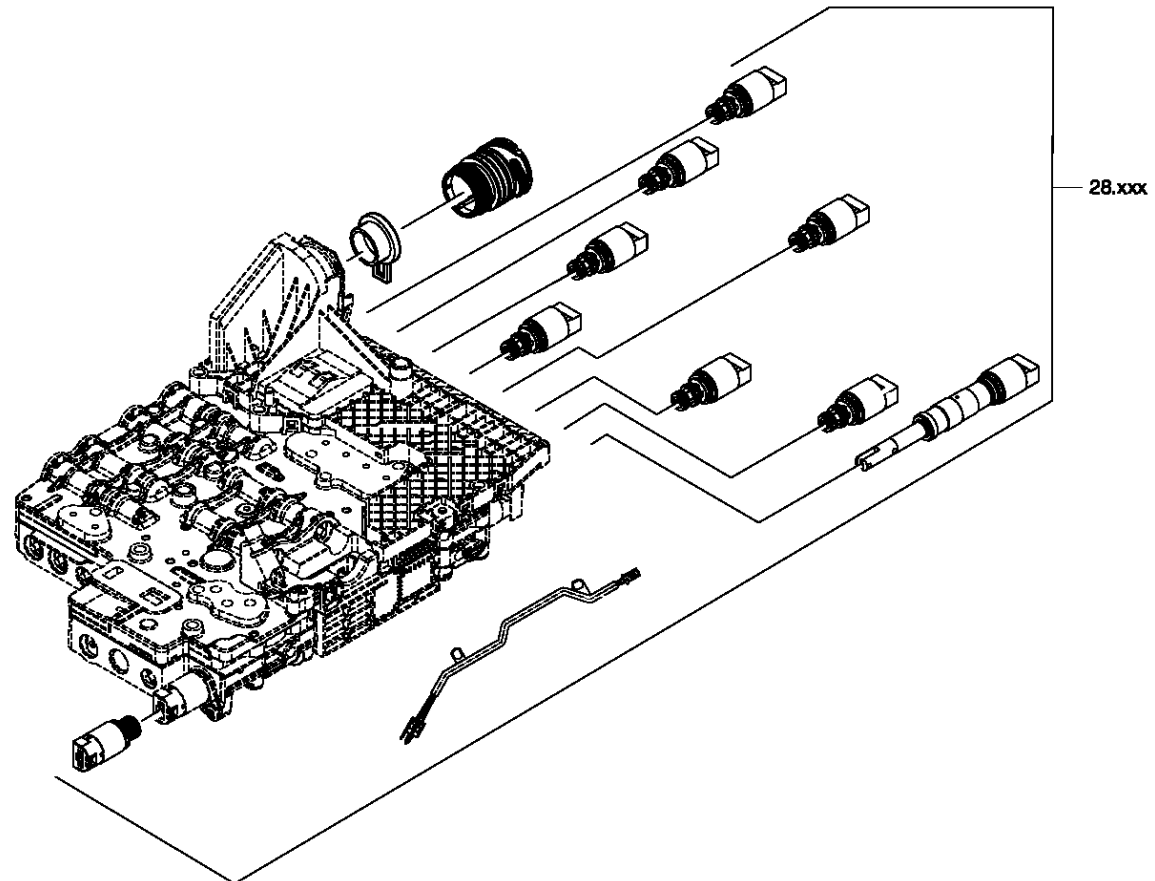

6 HP xx
E-Sch.

Picture

Page 1 from 6

Material number: 1068.010.026

Picture: 1068_298_609-1

Material-assembly-group-no: 1068.298.507



6 HP 26 / ()
REPAIR KIT VALVE

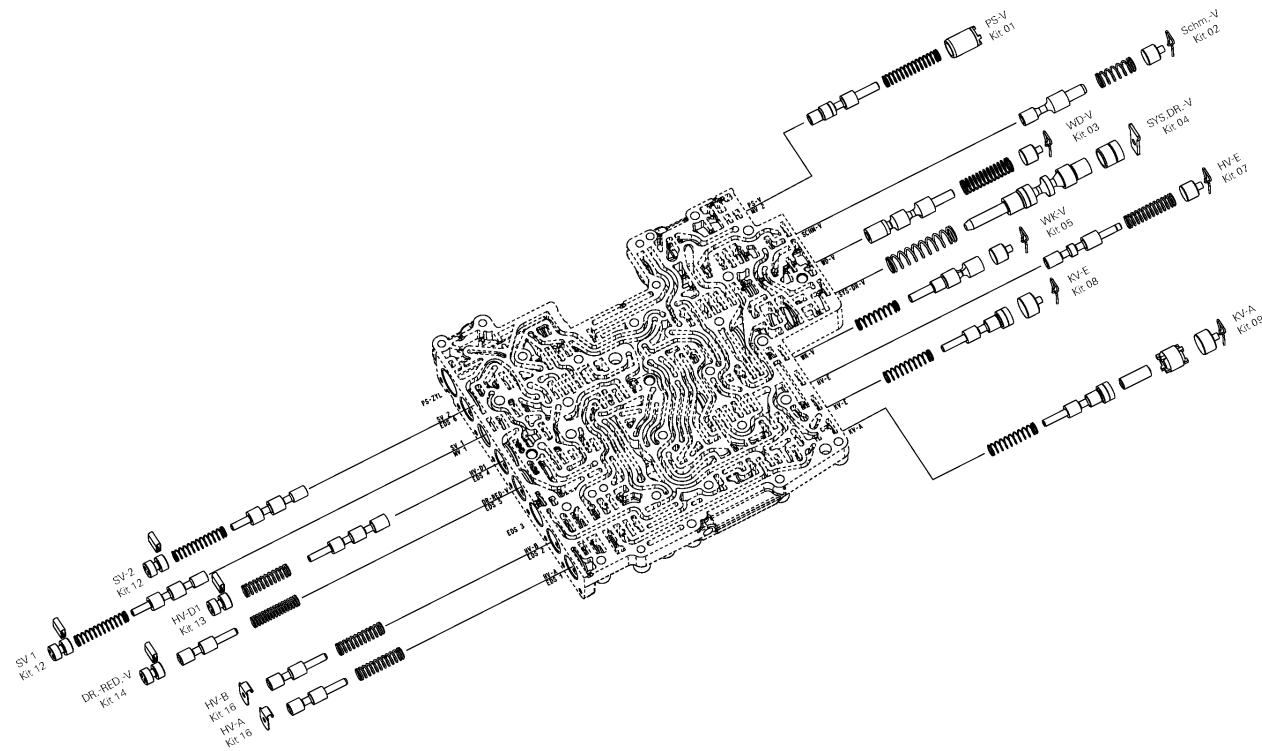

E20/2

Picture

Page 2 from 6

Material number: 1068.010.026

Picture: 1068_298_609-2

Material-assembly-group-no: 1068.298.507



6 HP 26 / ()
REPAIR KIT VALVE

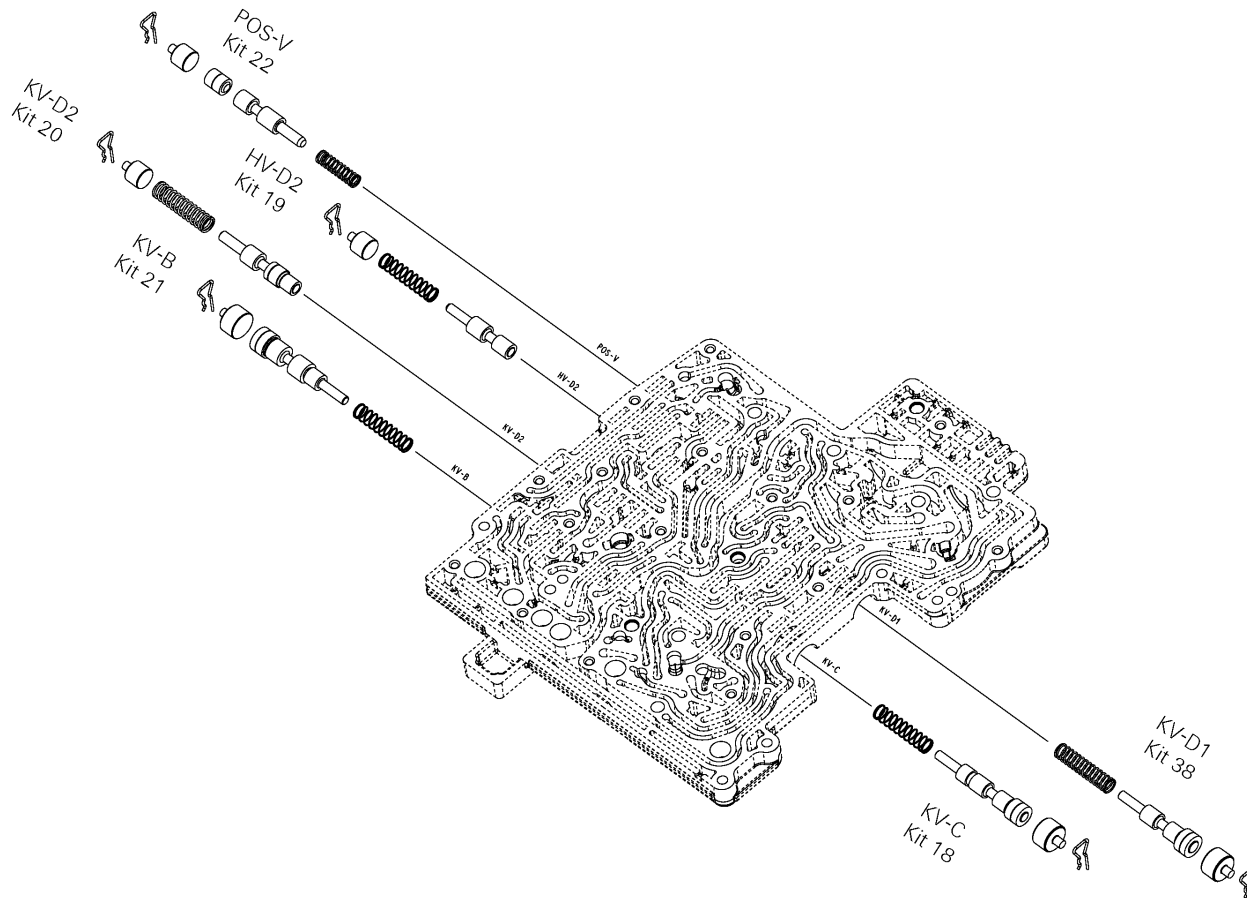

E20/2

Picture

Page 3 from 6

Material number: 1068.010.026

Picture: 1068_298_609-3

Material-assembly-group-no: 1068.298.507



6 HP 26 / ()
REPAIR KIT VALVE

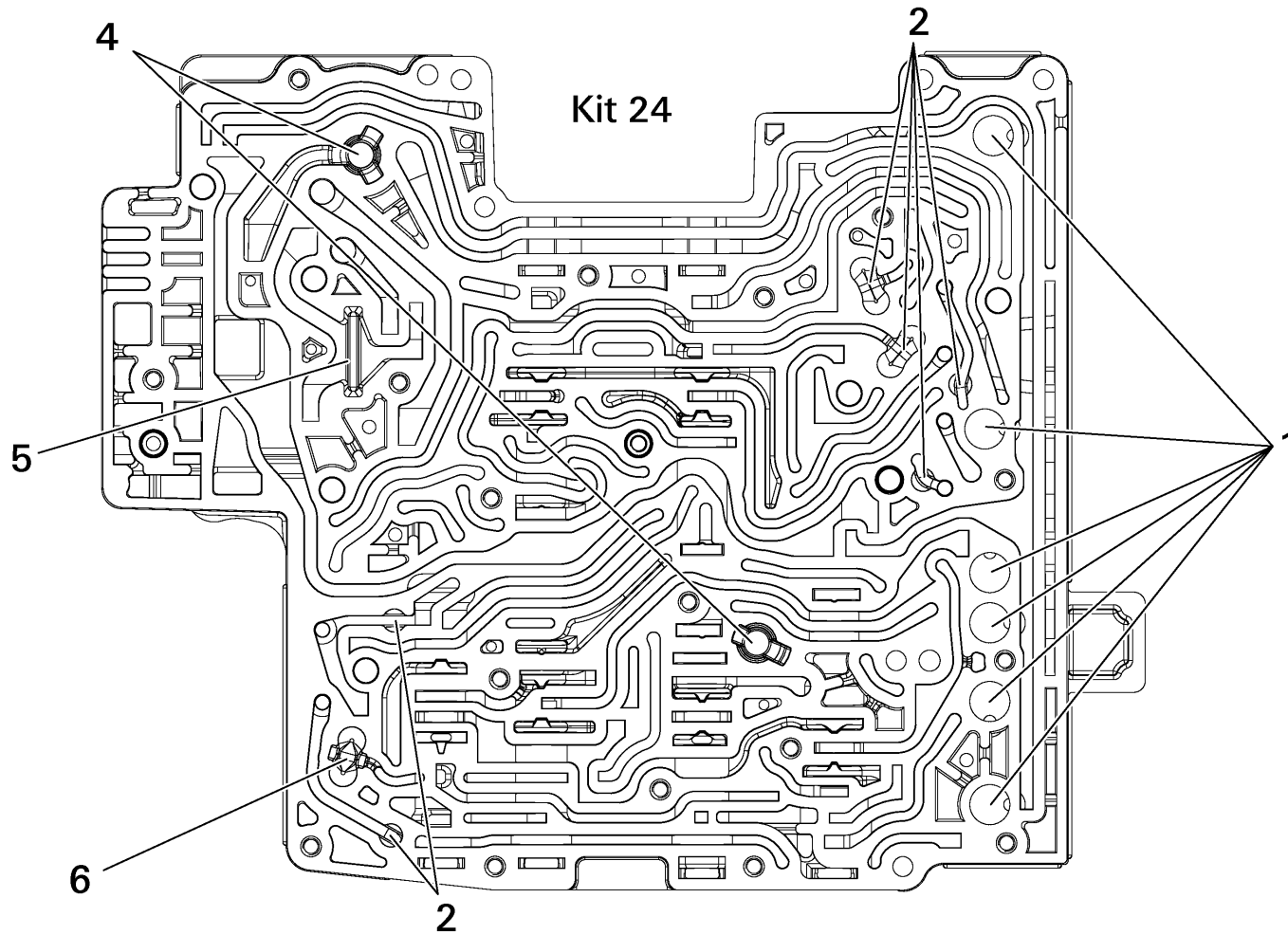

E20/2

Picture

Page 4 from 6

Material number: 1068.010.026

Picture: 1068_298_609-4

Material-assembly-group-no: 1068.298.507



6 HP 26 / ()
REPAIR KIT VALVE

1 - Kit 24

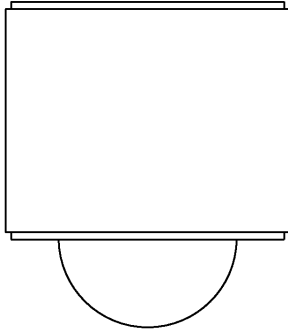

2 - Kit 24

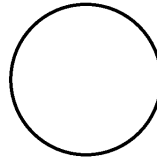

6 - Kit 24

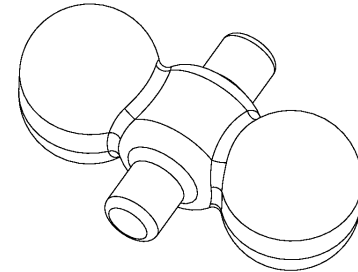

4 - Kit 24

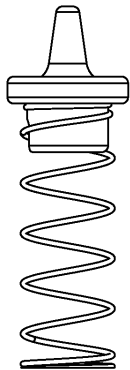

5 - Kit 24

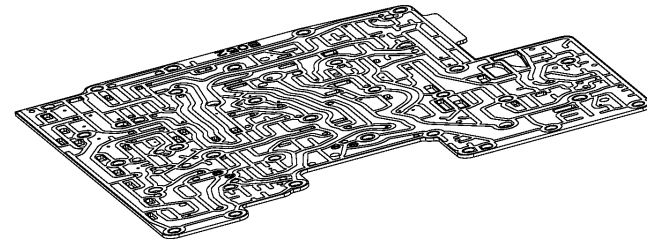
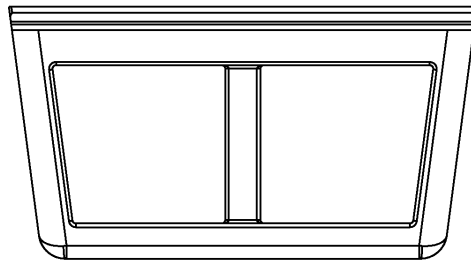

ET Zwischenblech

E20/2

Picture

Page 5 from 6

Material number: 1068.010.026

Picture: 114.D4.01-1

Material-assembly-group-no: 1068.298.507



6 HP 26 / ()
REPAIR KIT VALVE

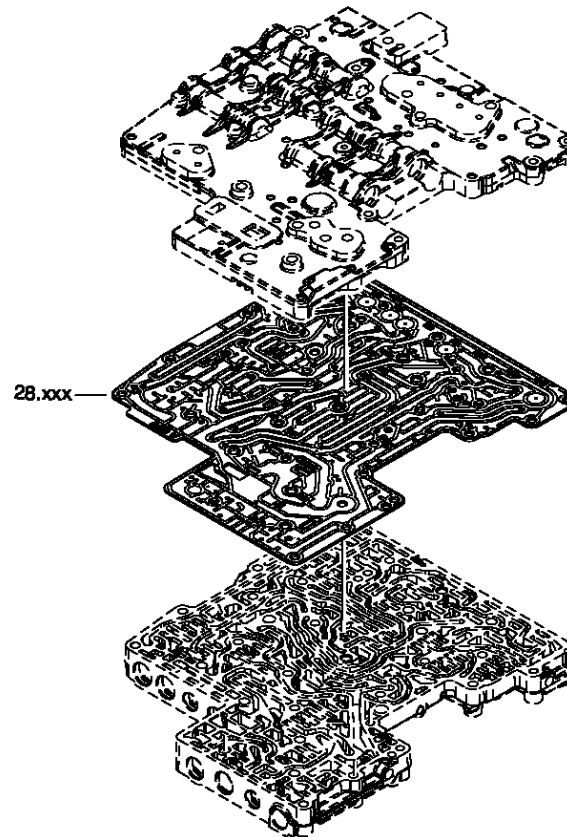

6 HP xx

Picture

Page 6 from 6

Material number: 1068.010.026

Picture: 114.G6.01-1

Material-assembly-group-no: 1068.298.507



6 HP 26 / ()
REPAIR KIT VALVE

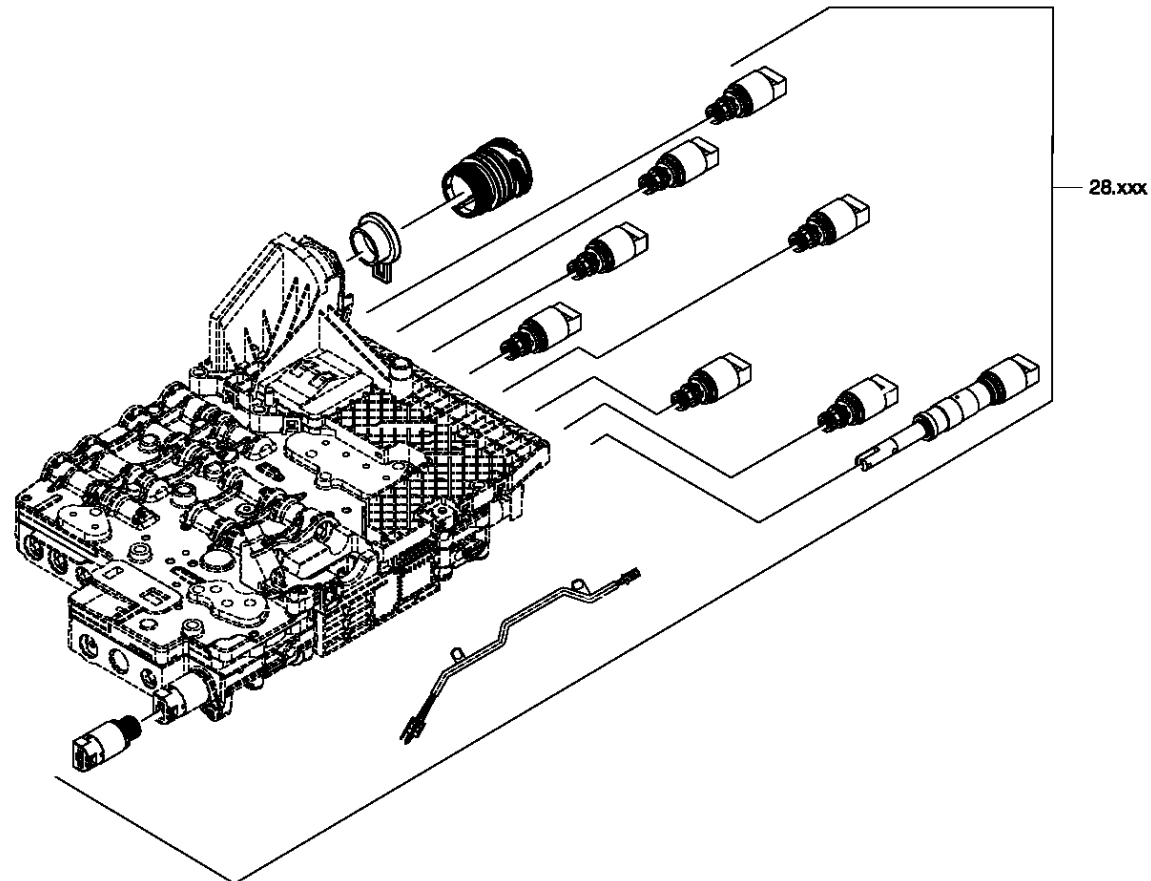

6 HP xx
E-Sch.

Picture

Page 1 from 6

Material number: 1068.010.026

Picture: 1068_298_609-1

Material-assembly-group-no: 1068.298.508



6 HP 26 / ()
REPAIR KIT VALVE

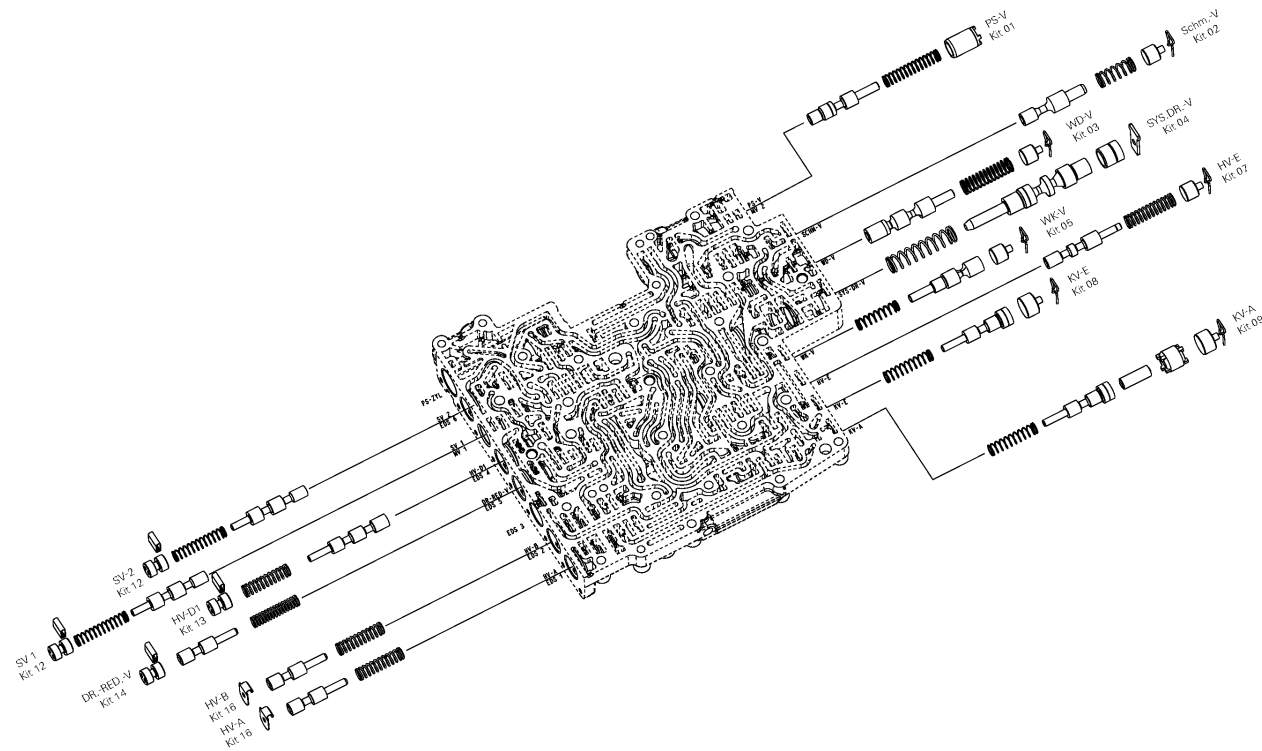

E20/2

Picture

Page 2 from 6

Material number: 1068.010.026

Picture: 1068_298_609-2

Material-assembly-group-no: 1068.298.508



6 HP 26 / ()
REPAIR KIT VALVE

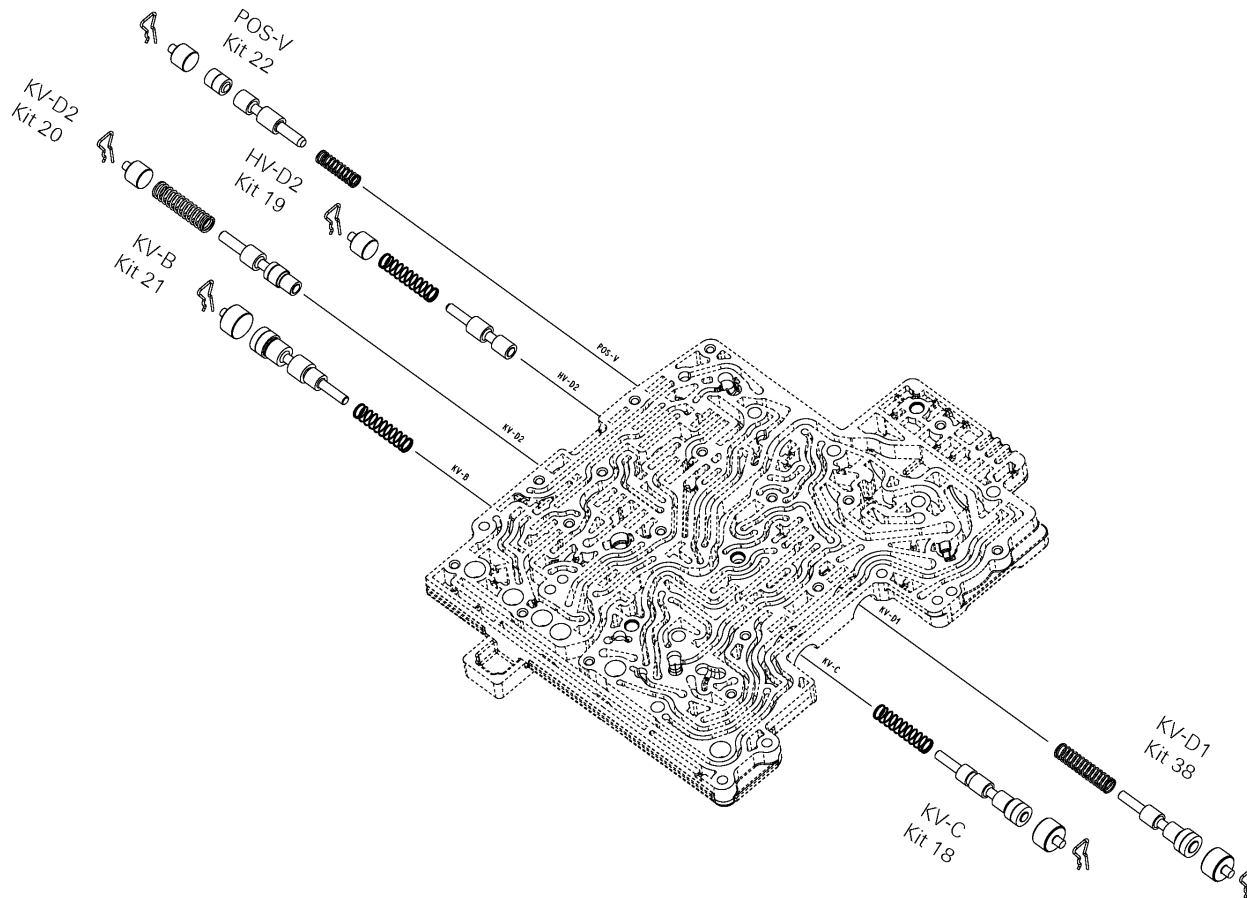

E20/2

Picture

Page 3 from 6

Material number: 1068.010.026

Picture: 1068_298_609-3

Material-assembly-group-no: 1068.298.508



6 HP 26 / ()
REPAIR KIT VALVE

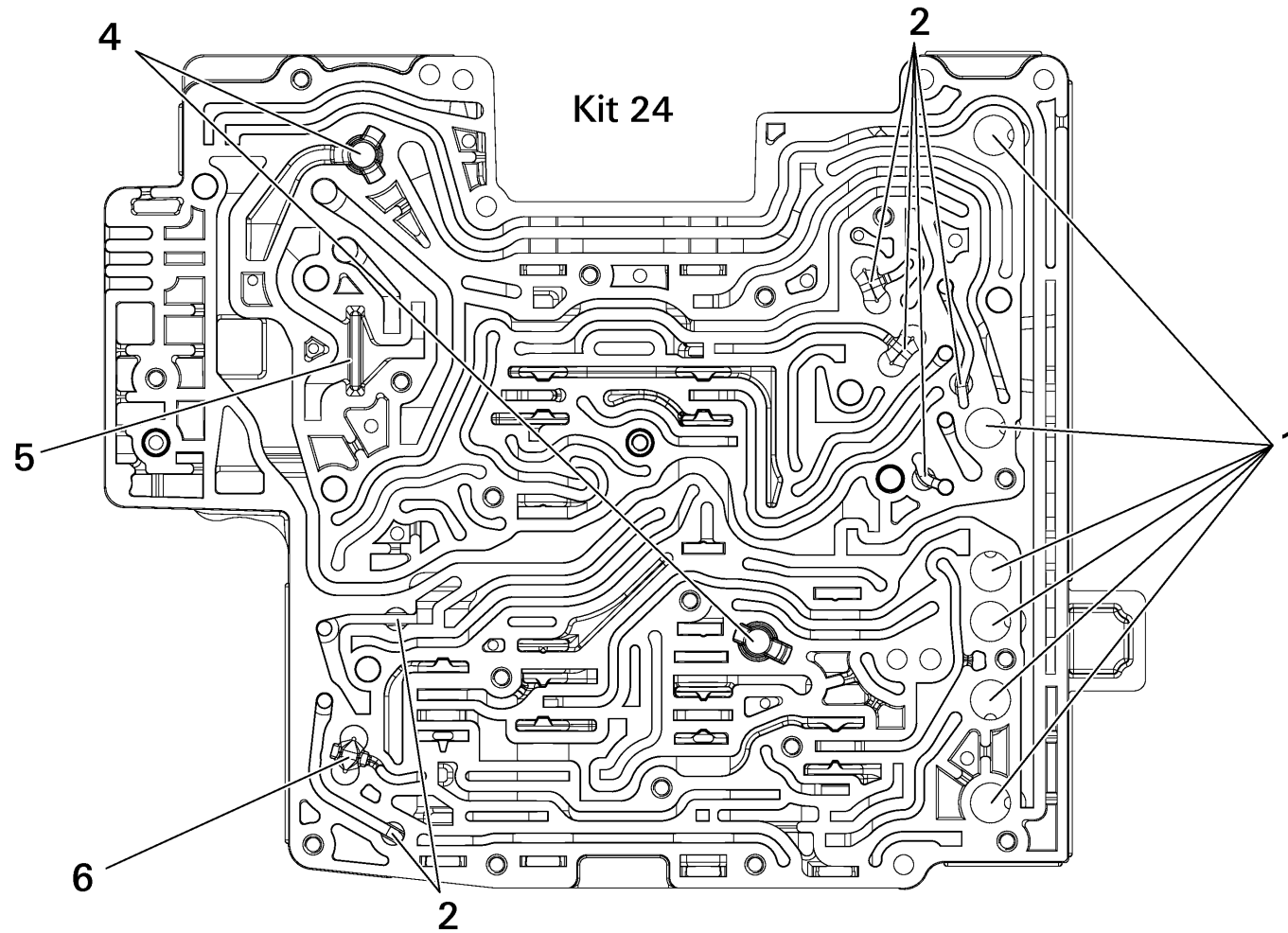

E20/2

Picture

Page 4 from 6

Material number: 1068.010.026

Picture: 1068_298_609-4

Material-assembly-group-no: 1068.298.508



6 HP 26 / ()
REPAIR KIT VALVE

1 - Kit 24

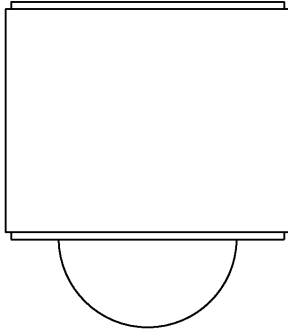

2 - Kit 24

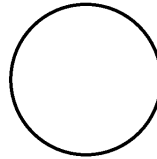

6 - Kit 24

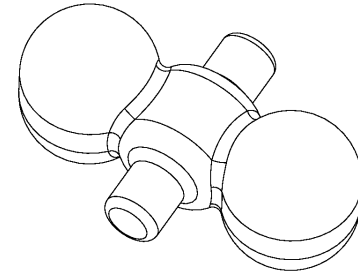

4 - Kit 24

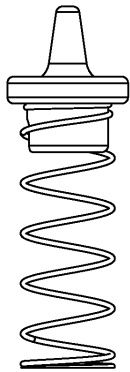

5 - Kit 24

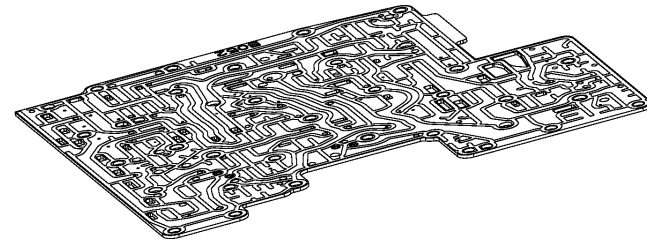
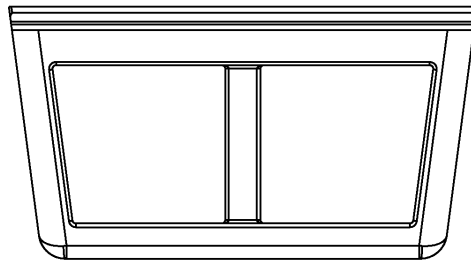

ET Zwischenblech

E20/2

Picture

Page 5 from 6

Material number: 1068.010.026

Picture: 114.D4.01-1

Material-assembly-group-no: 1068.298.508



6 HP 26 / ()
REPAIR KIT VALVE

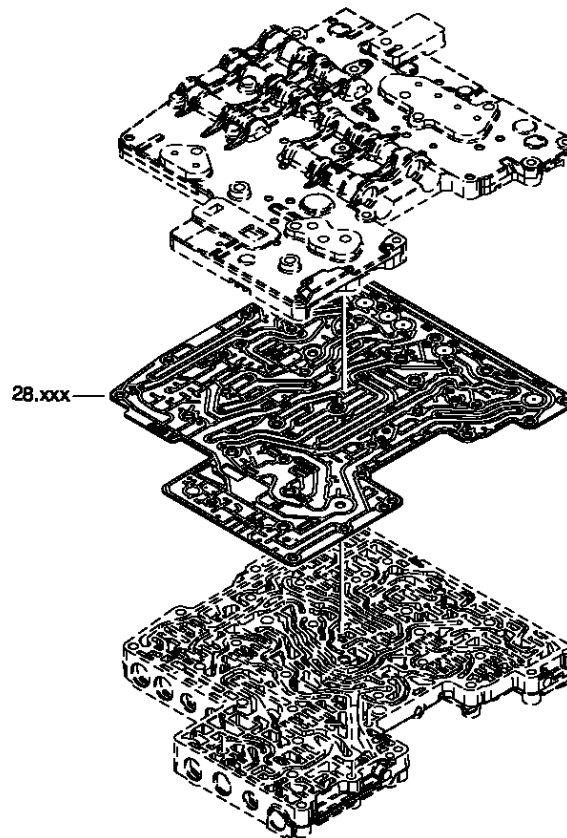

6 HP xx

Picture

Page 6 from 6

Material number: 1068.010.026

Picture: 114.G6.01-1

Material-assembly-group-no: 1068.298.508



6 HP 26 / ()
REPAIR KIT VALVE

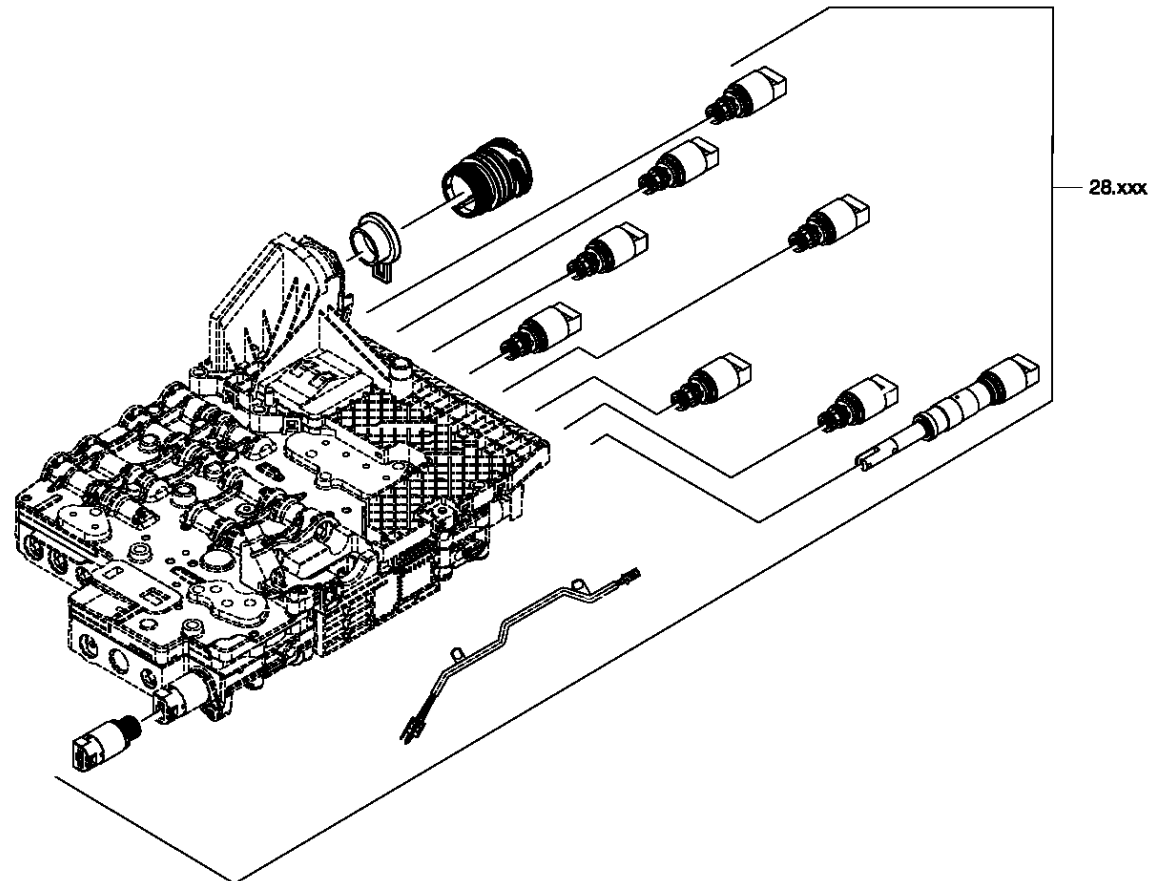

6 HP xx
E-Sch.

Picture

Page 1 from 6

Material number: 1068.010.026

Picture: 1068_298_609-1

Material-assembly-group-no: 1068.298.509



6 HP 26 / ()
REPAIR KIT VALVE

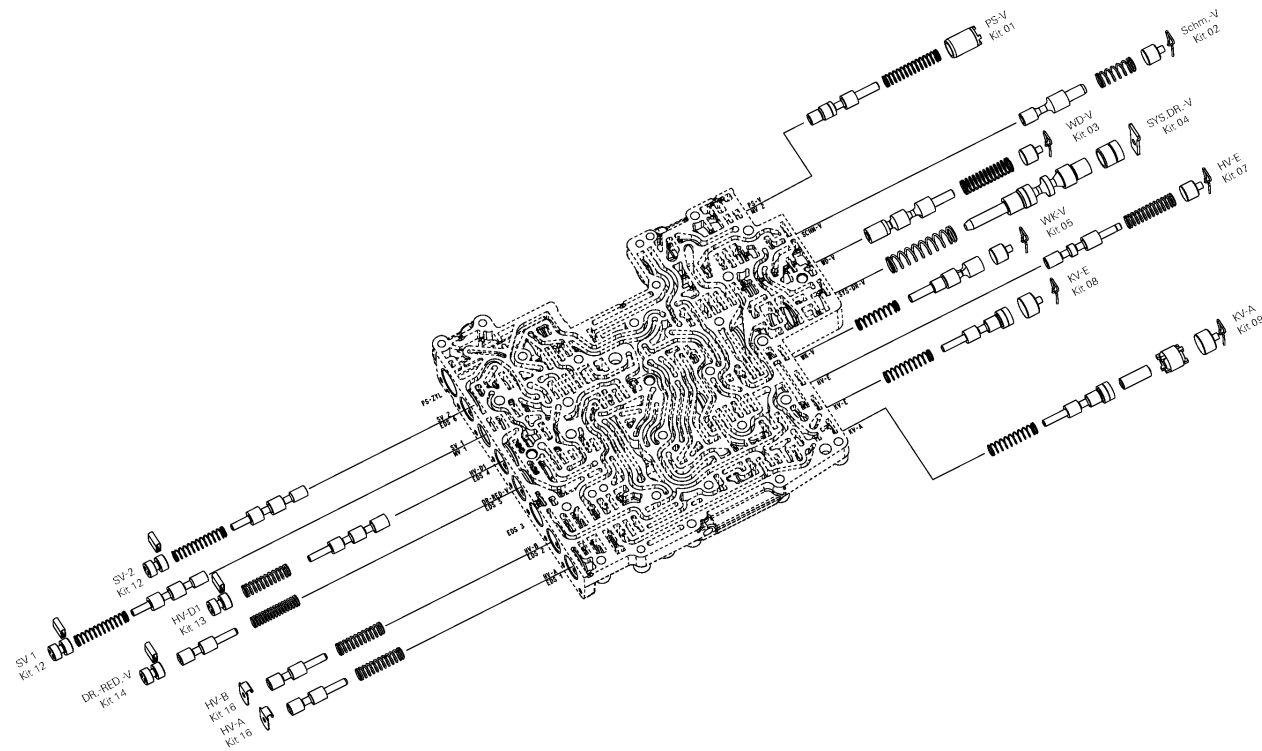

E20/2

Picture

Page 2 from 6

Material number: 1068.010.026

Picture: 1068_298_609-2

Material-assembly-group-no: 1068.298.509



6 HP 26 / ()
REPAIR KIT VALVE

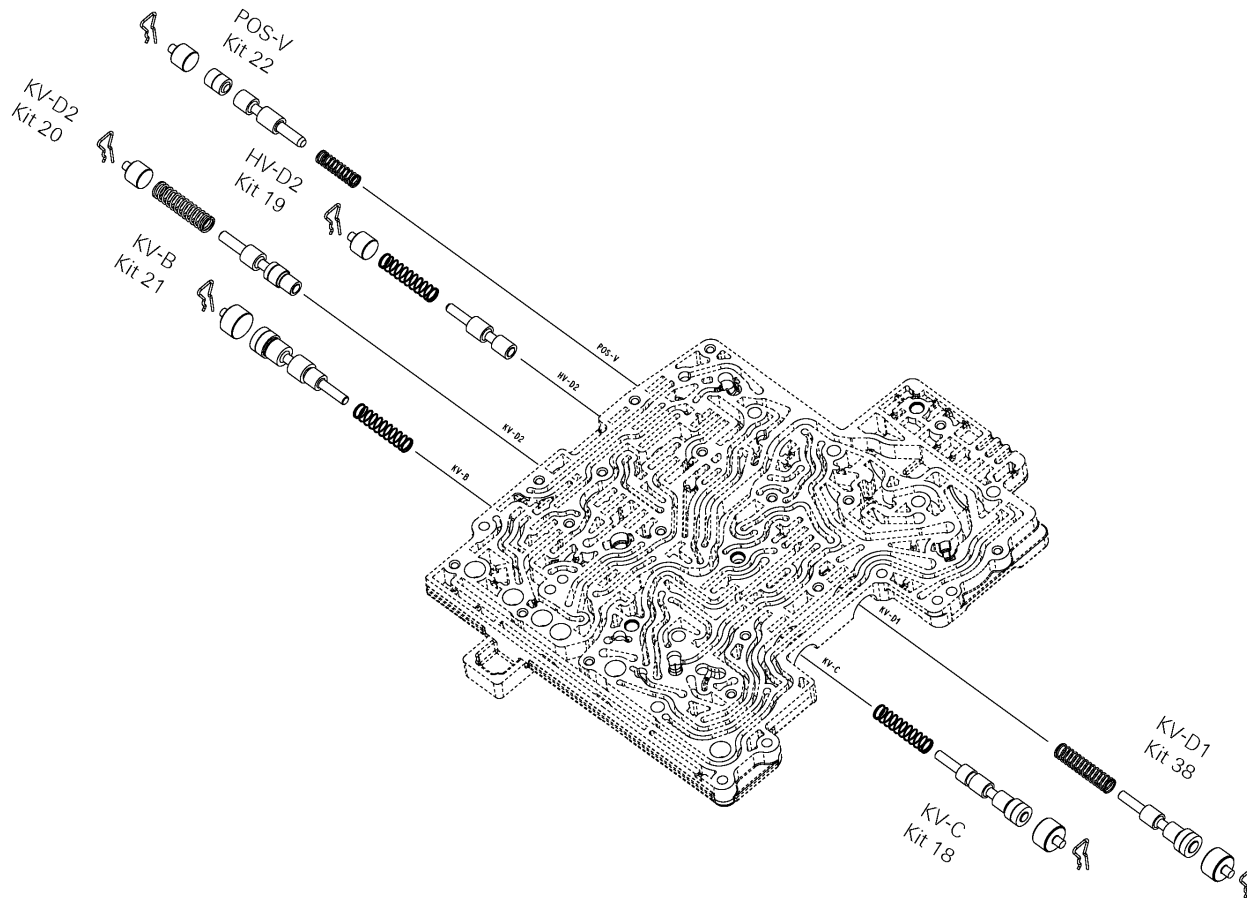

E20/2

Picture

Page 3 from 6

Material number: 1068.010.026

Picture: 1068_298_609-3

Material-assembly-group-no: 1068.298.509



6 HP 26 / ()
REPAIR KIT VALVE

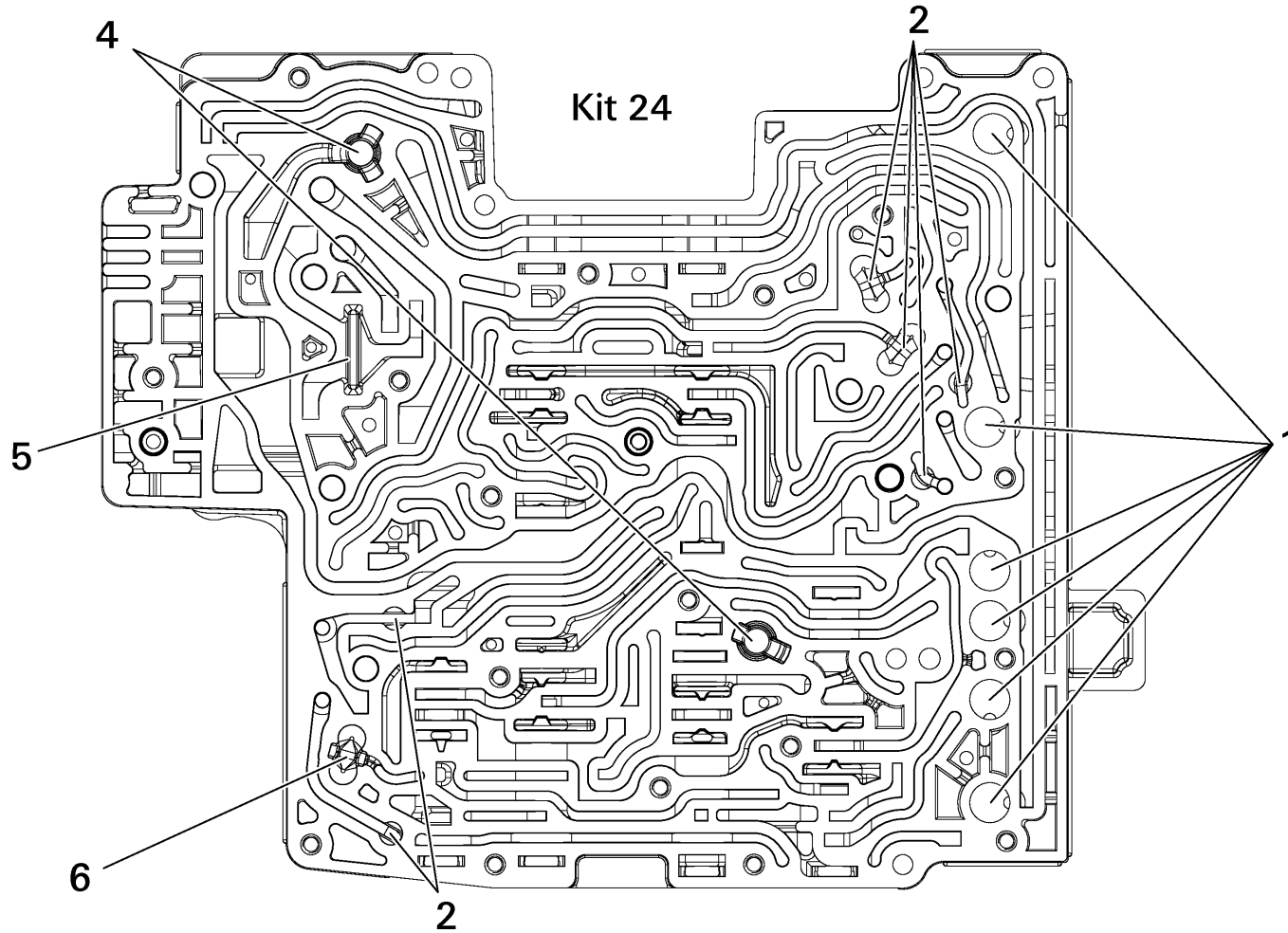

E20/2

Picture

Page 4 from 6

Material number: 1068.010.026

Picture: 1068_298_609-4

Material-assembly-group-no: 1068.298.509



6 HP 26 / ()
REPAIR KIT VALVE

1 - Kit 24

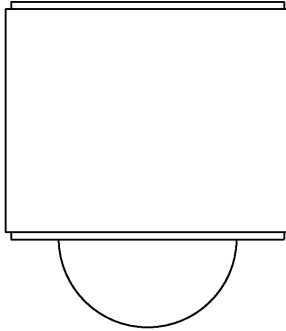

2 - Kit 24

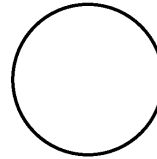

6 - Kit 24

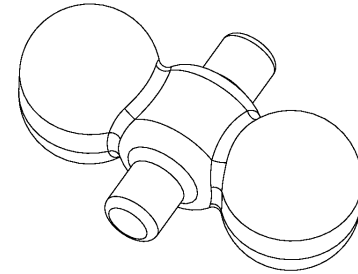

4 - Kit 24

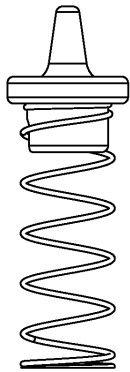

5 - Kit 24

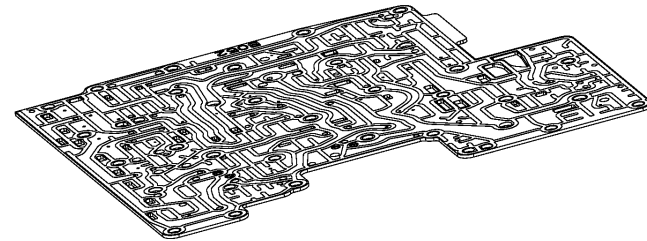
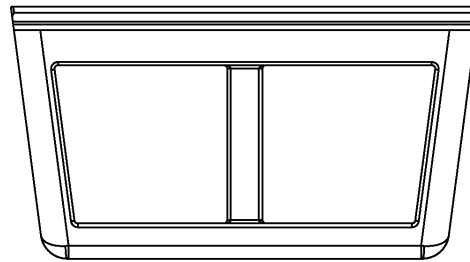

ET Zwischenblech

E20/2

Picture

Page 5 from 6

Material number: 1068.010.026

Picture: 114.D4.01-1

Material-assembly-group-no: 1068.298.509



6 HP 26 / ()
REPAIR KIT VALVE

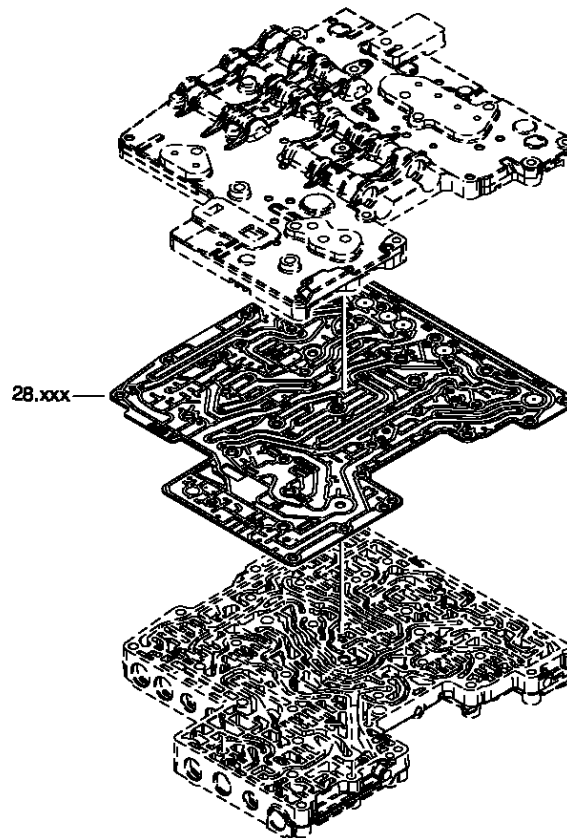

6 HP xx

Picture

Page 6 from 6

Material number: 1068.010.026

Picture: 114.G6.01-1

Material-assembly-group-no: 1068.298.509



6 HP 26 / ()
REPAIR KIT VALVE

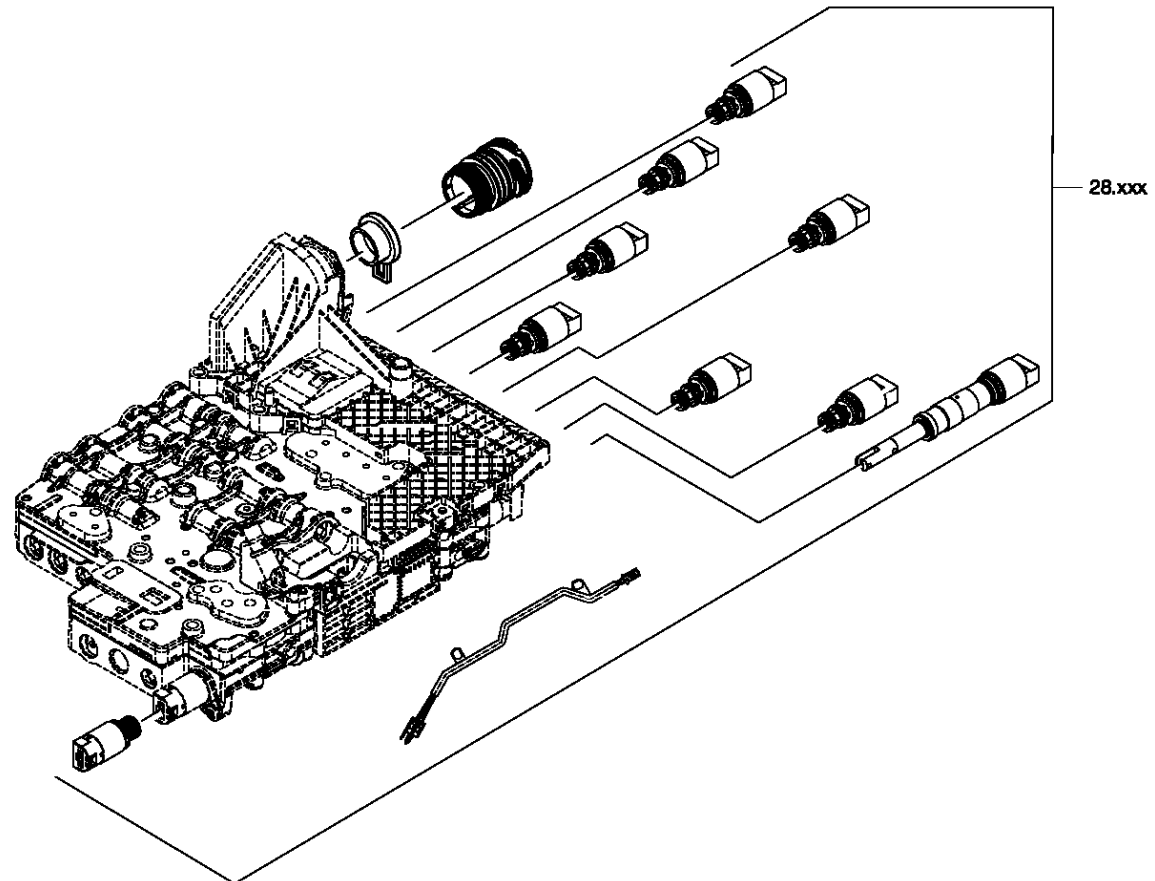

6 HP xx
E-Sch.

Picture

Page 1 from 6

Material number: 1068.010.026

Picture: 1068_298_609-1

Material-assembly-group-no: 1068.298.512



6 HP 26 / ()
REPAIR KIT VALVE

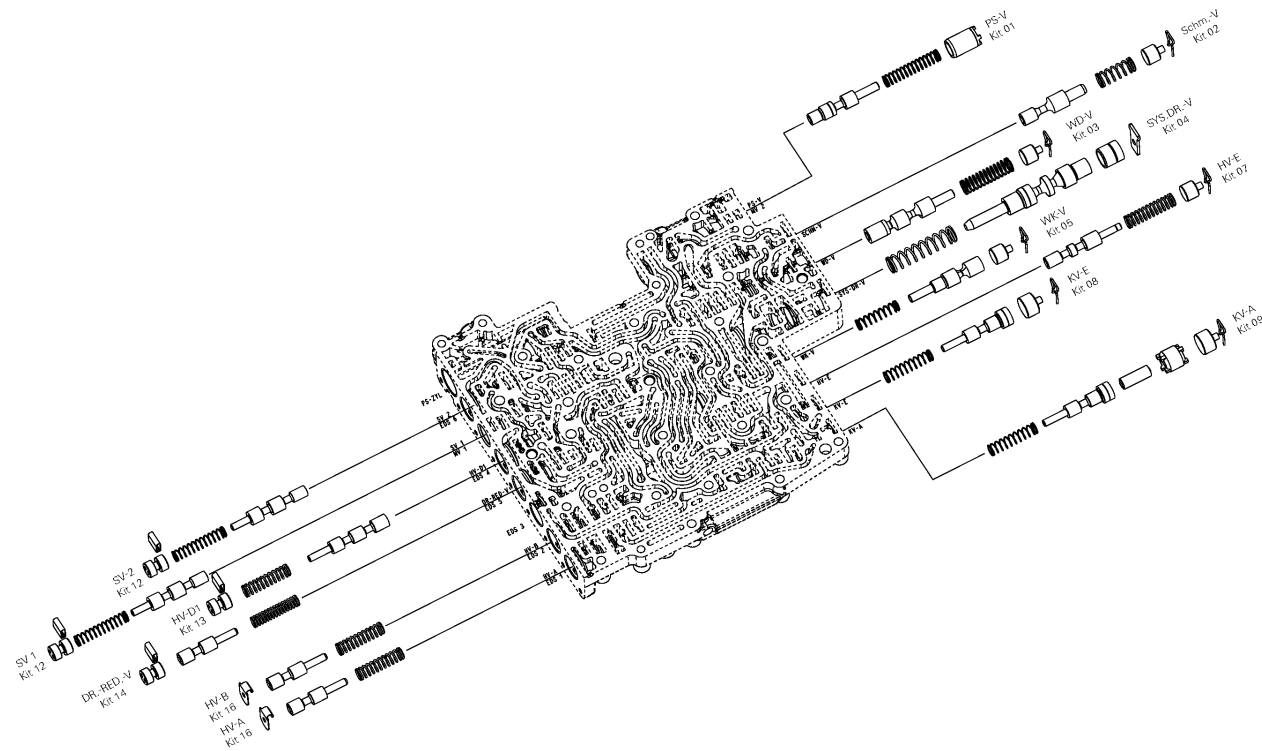

E20/2

Picture

Page 2 from 6

Material number: 1068.010.026

Picture: 1068_298_609-2

Material-assembly-group-no: 1068.298.512



6 HP 26 / ()
REPAIR KIT VALVE

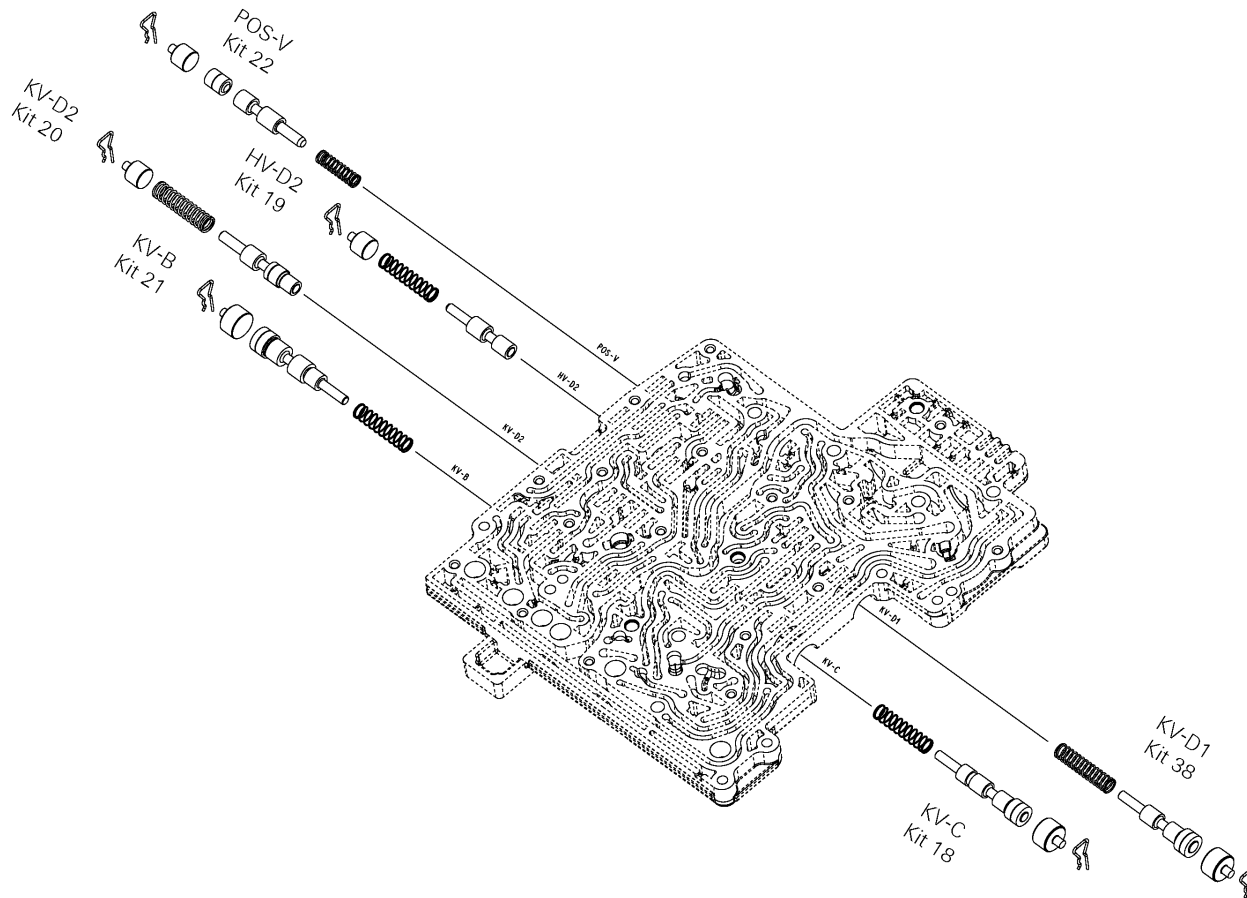

E20/2

Picture

Page 3 from 6

Material number: 1068.010.026

Picture: 1068_298_609-3

Material-assembly-group-no: 1068.298.512



6 HP 26 / ()
REPAIR KIT VALVE

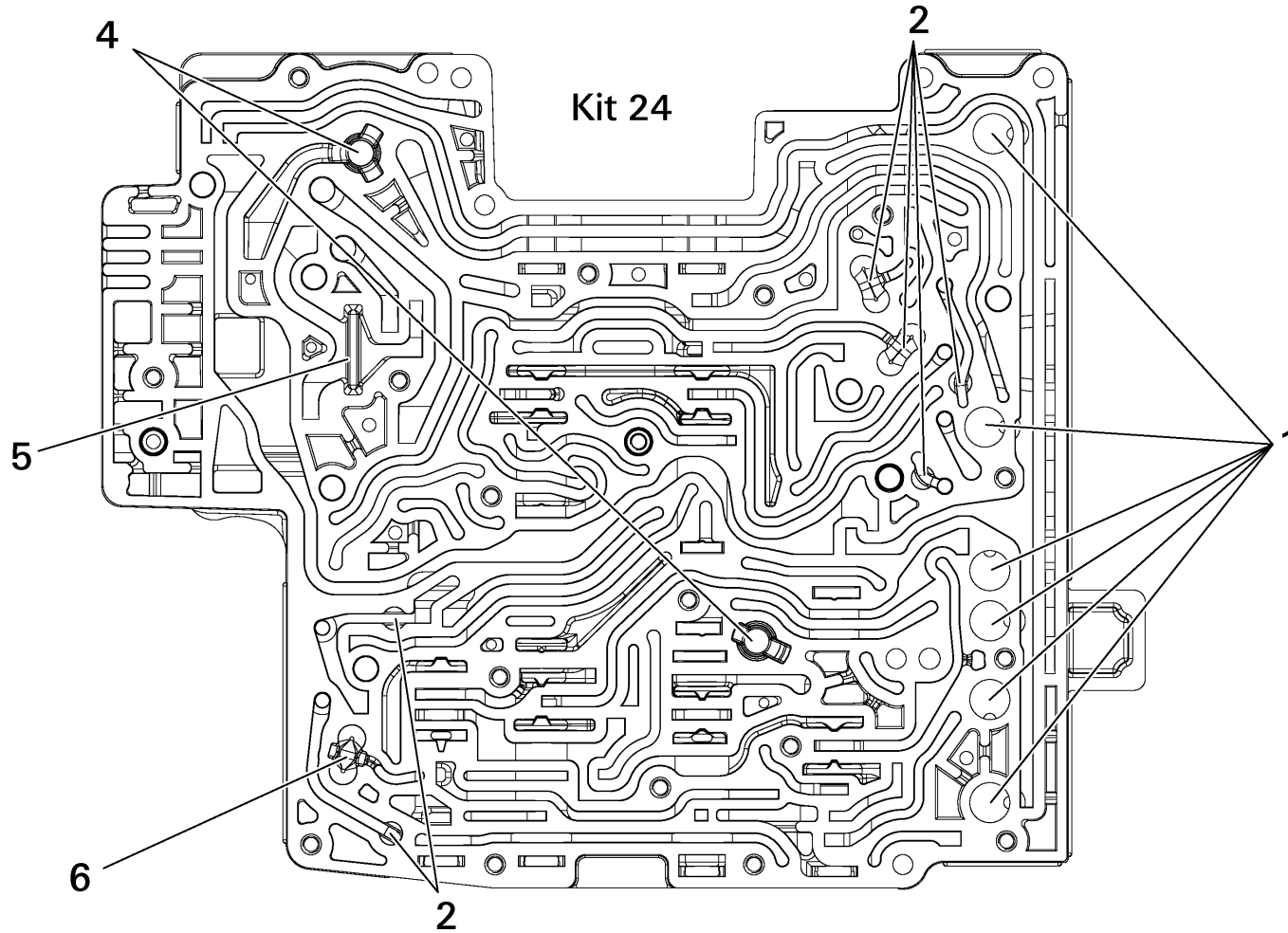

E20/2

Picture

Page 4 from 6

Material number: 1068.010.026

Picture: 1068_298_609-4

Material-assembly-group-no: 1068.298.512



6 HP 26 / ()
REPAIR KIT VALVE

1 - Kit 24

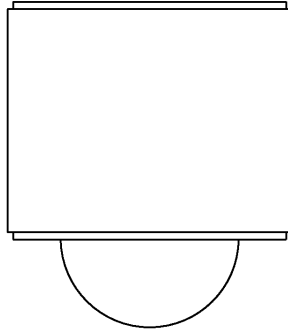

2 - Kit 24

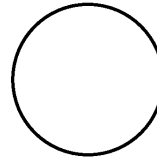

6 - Kit 24

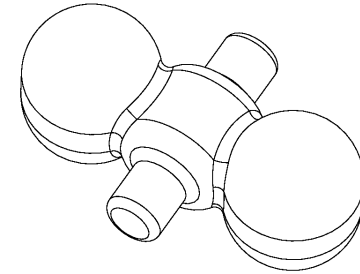

4 - Kit 24

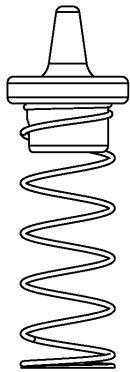

5 - Kit 24

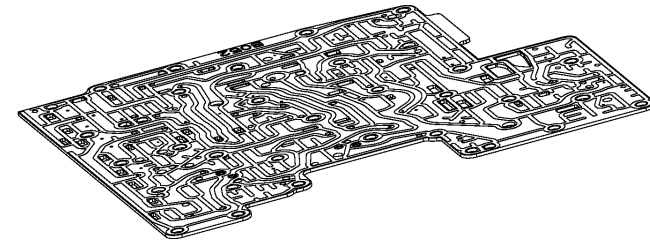
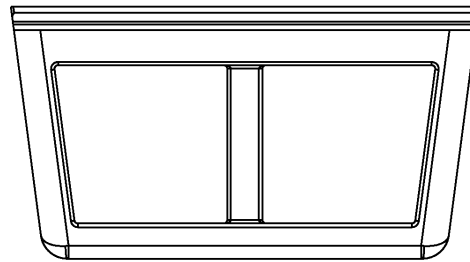

ET Zwischenblech

E20/2

Picture

Page 5 from 6

Material number: 1068.010.026

Picture: 114.D4.01-1

Material-assembly-group-no: 1068.298.512



6 HP 26 / ()
REPAIR KIT VALVE

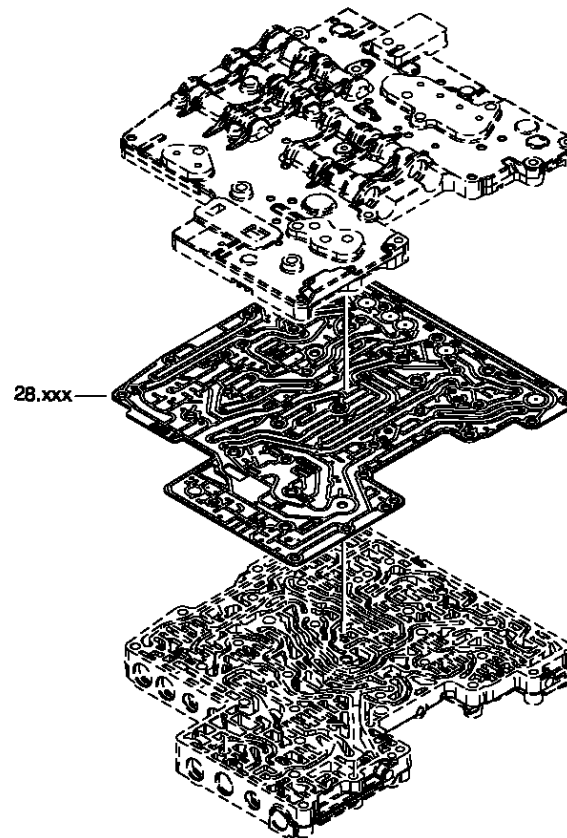

6 HP xx

Picture

Page 6 from 6

Material number: 1068.010.026

Picture: 114.G6.01-1

Material-assembly-group-no: 1068.298.512



6 HP 26 / ()
REPAIR KIT VALVE

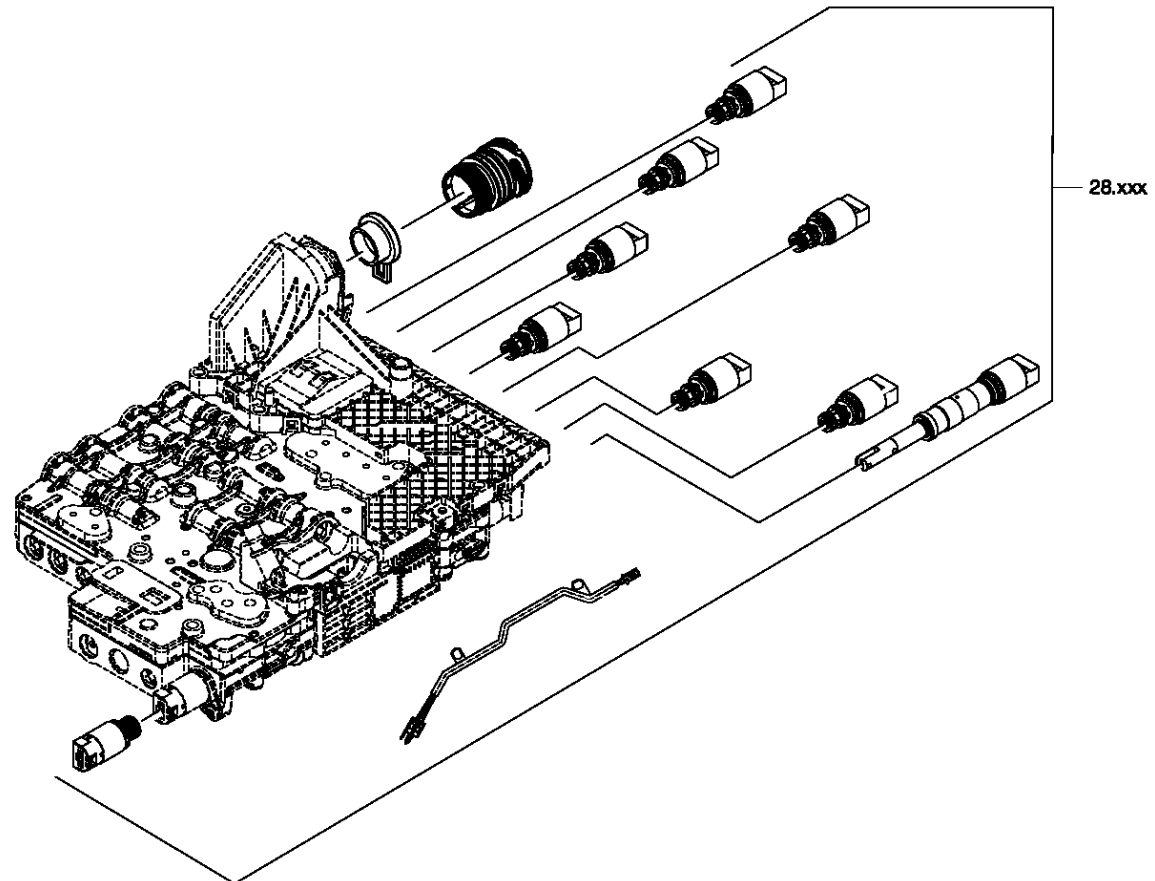

6 HP xx
E-Sch.

Picture

Page 1 from 6

Material number: 1068.010.026

Picture: 1068_298_609-1

Material-assembly-group-no: 1068.298.513



6 HP 26 / ()
REPAIR KIT VALVE

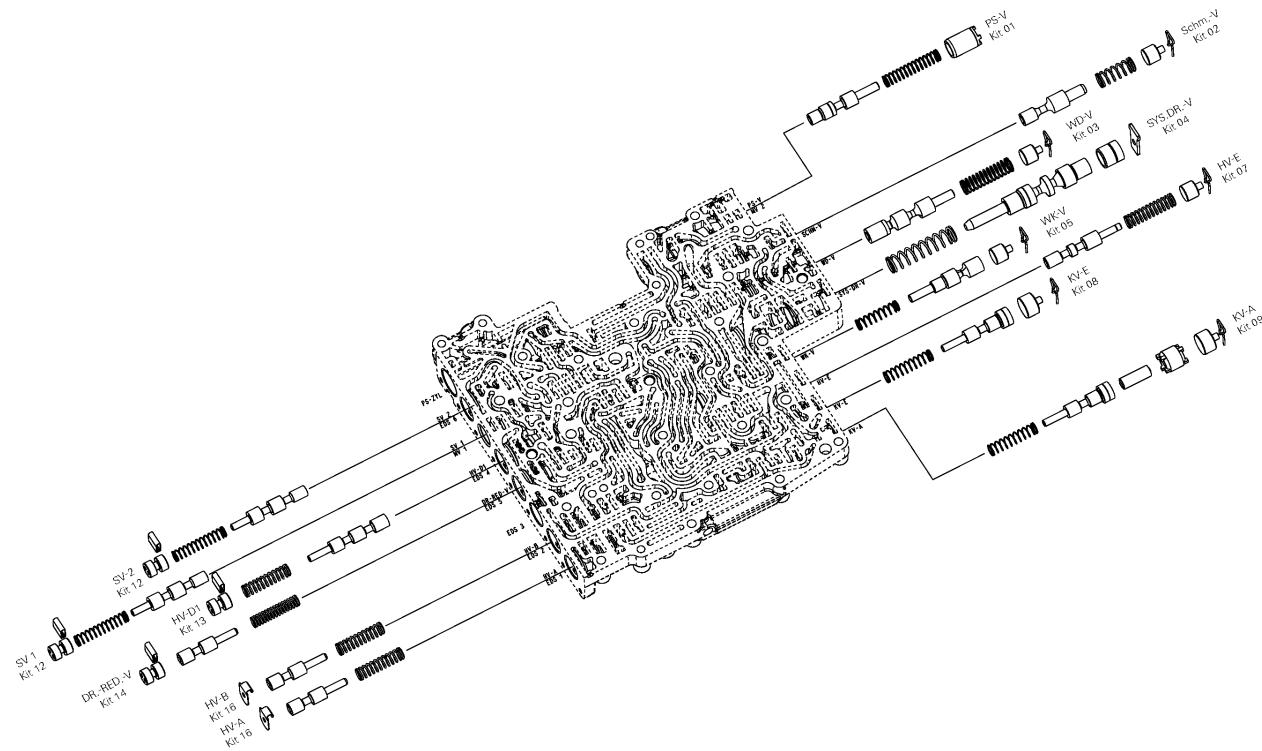

E20/2

Picture

Page 2 from 6

Material number: 1068.010.026

Picture: 1068_298_609-2

Material-assembly-group-no: 1068.298.513



6 HP 26 / ()
REPAIR KIT VALVE

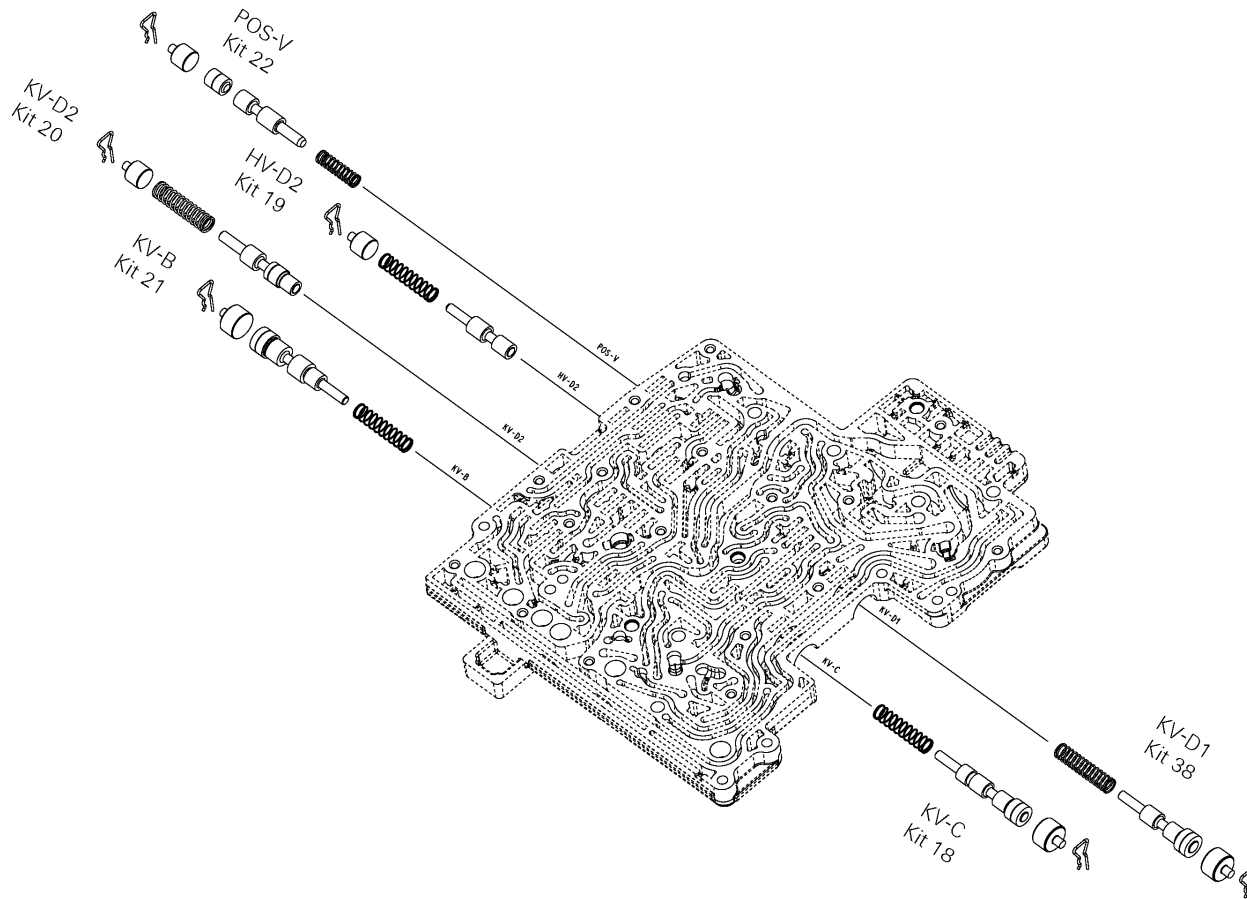

E20/2

Picture

Page 3 from 6

Material number: 1068.010.026

Picture: 1068_298_609-3

Material-assembly-group-no: 1068.298.513



6 HP 26 / ()
REPAIR KIT VALVE

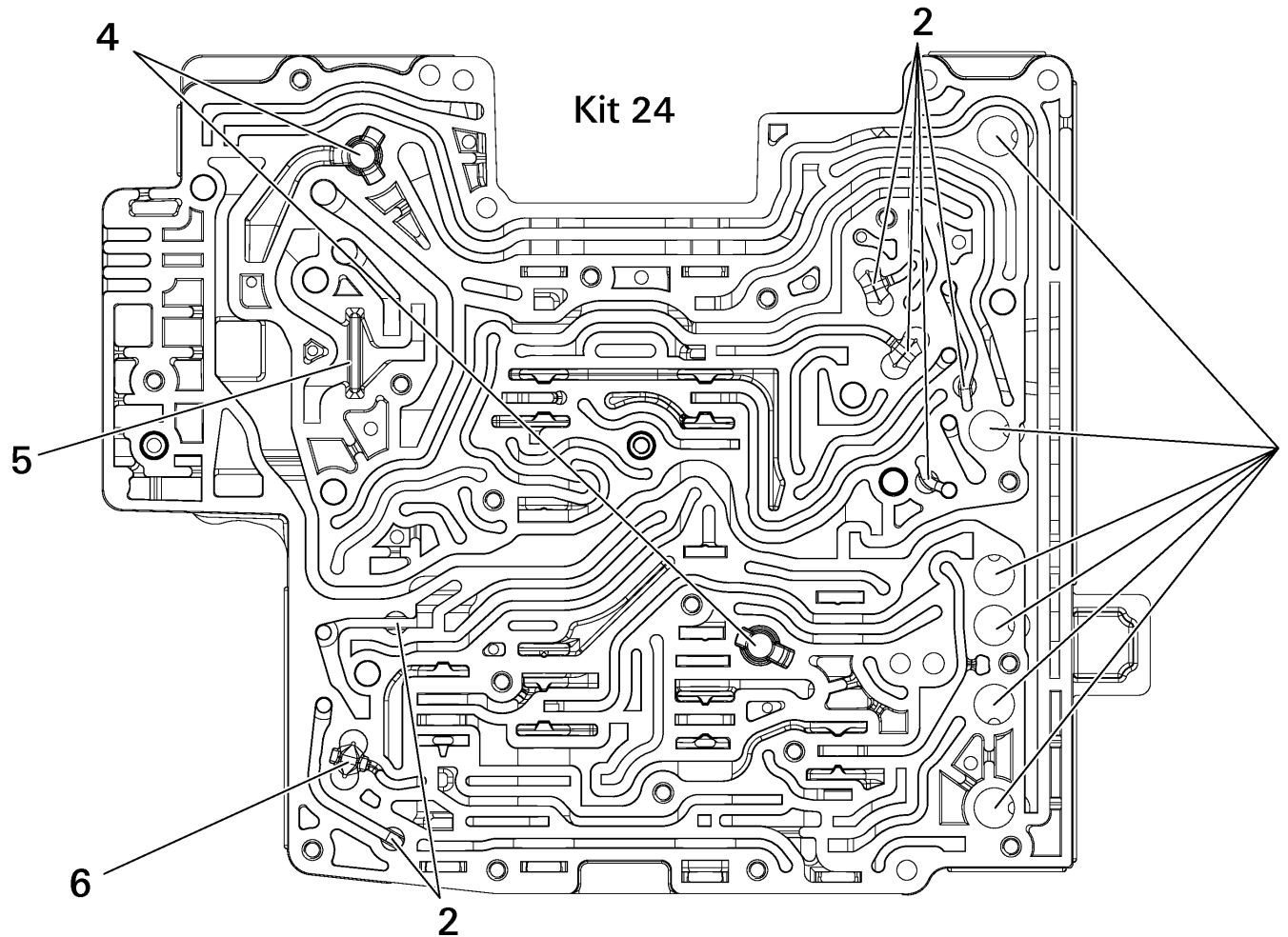

E20/2

Picture

Page 4 from 6

Material number: 1068.010.026

Picture: 1068_298_609-4

Material-assembly-group-no: 1068.298.513



6 HP 26 / ()
REPAIR KIT VALVE

1 - Kit 24

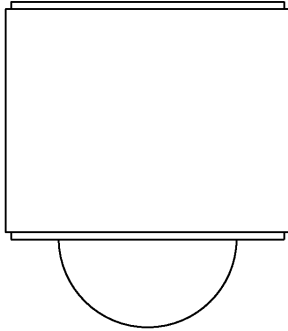

2 - Kit 24

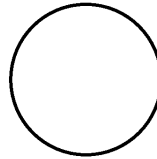

6 - Kit 24

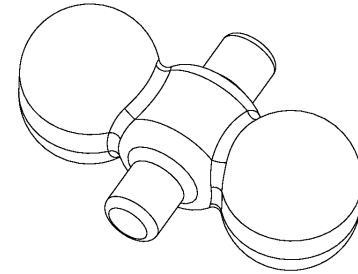

4 - Kit 24

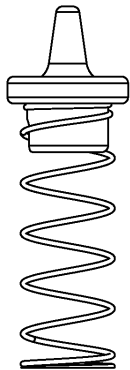

5 - Kit 24

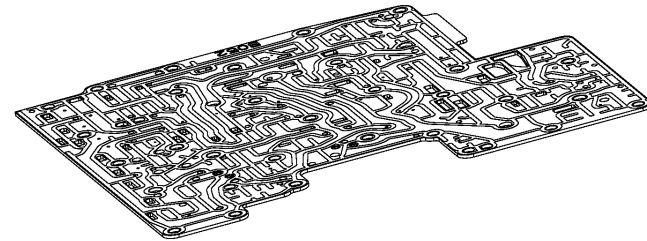
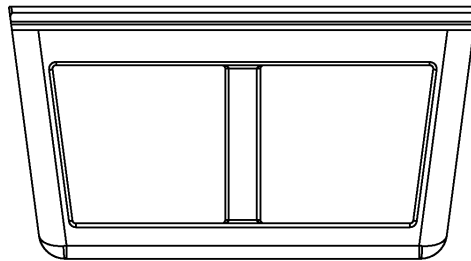

ET Zwischenblech

E20/2

Picture

Page 5 from 6

Material number: 1068.010.026

Picture: 114.D4.01-1

Material-assembly-group-no: 1068.298.513



6 HP 26 / ()
REPAIR KIT VALVE

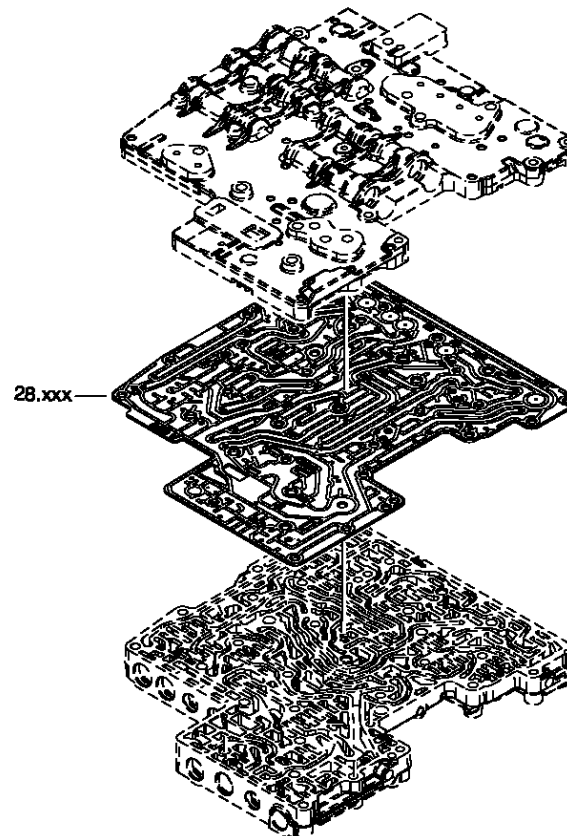

6 HP xx

Picture

Page 6 from 6

Material number: 1068.010.026

Picture: 114.G6.01-1

Material-assembly-group-no: 1068.298.513



6 HP 26 / ()
REPAIR KIT VALVE

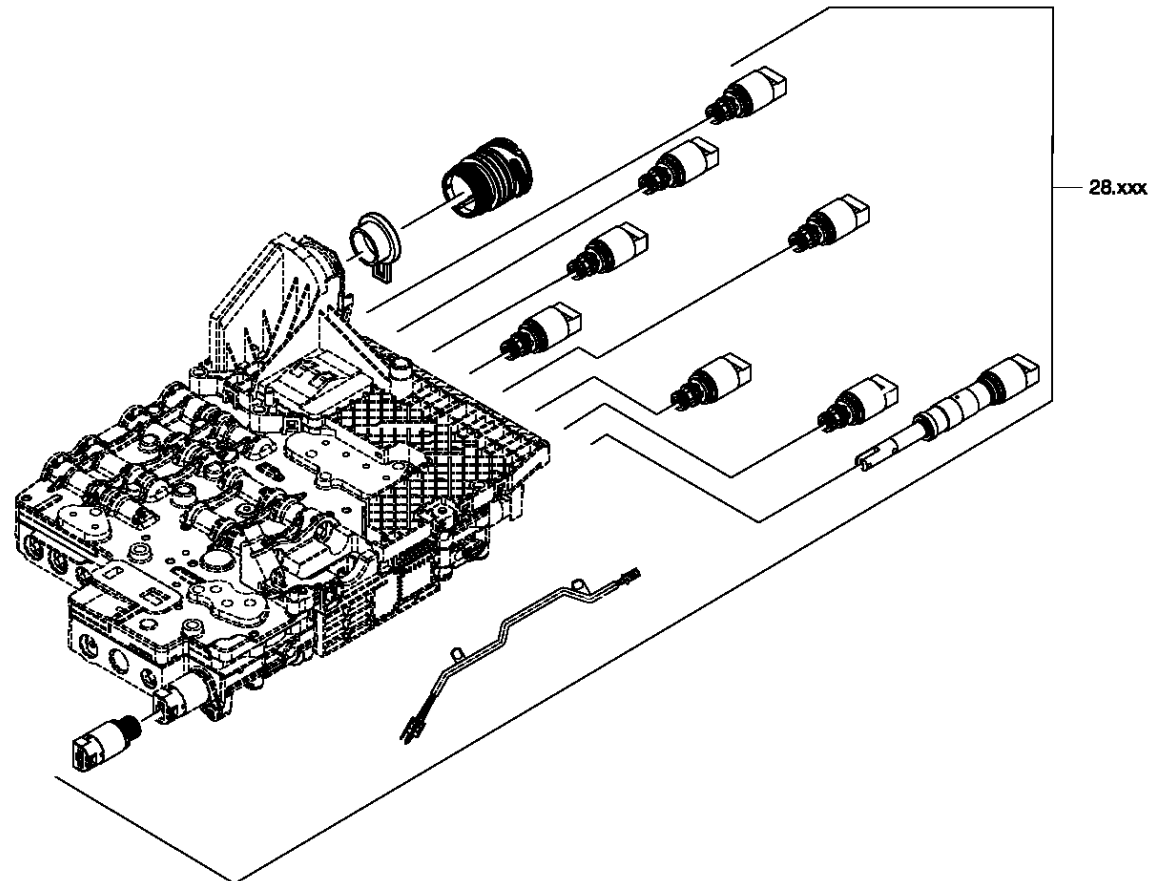

6 HP xx
E-Sch.

Picture

Page 2 from 6

Material number: 1068.010.026

Picture: 1068_298_609-2

Material-assembly-group-no: 1068.298.514



6 HP 26 / ()
REPAIR KIT VALVE

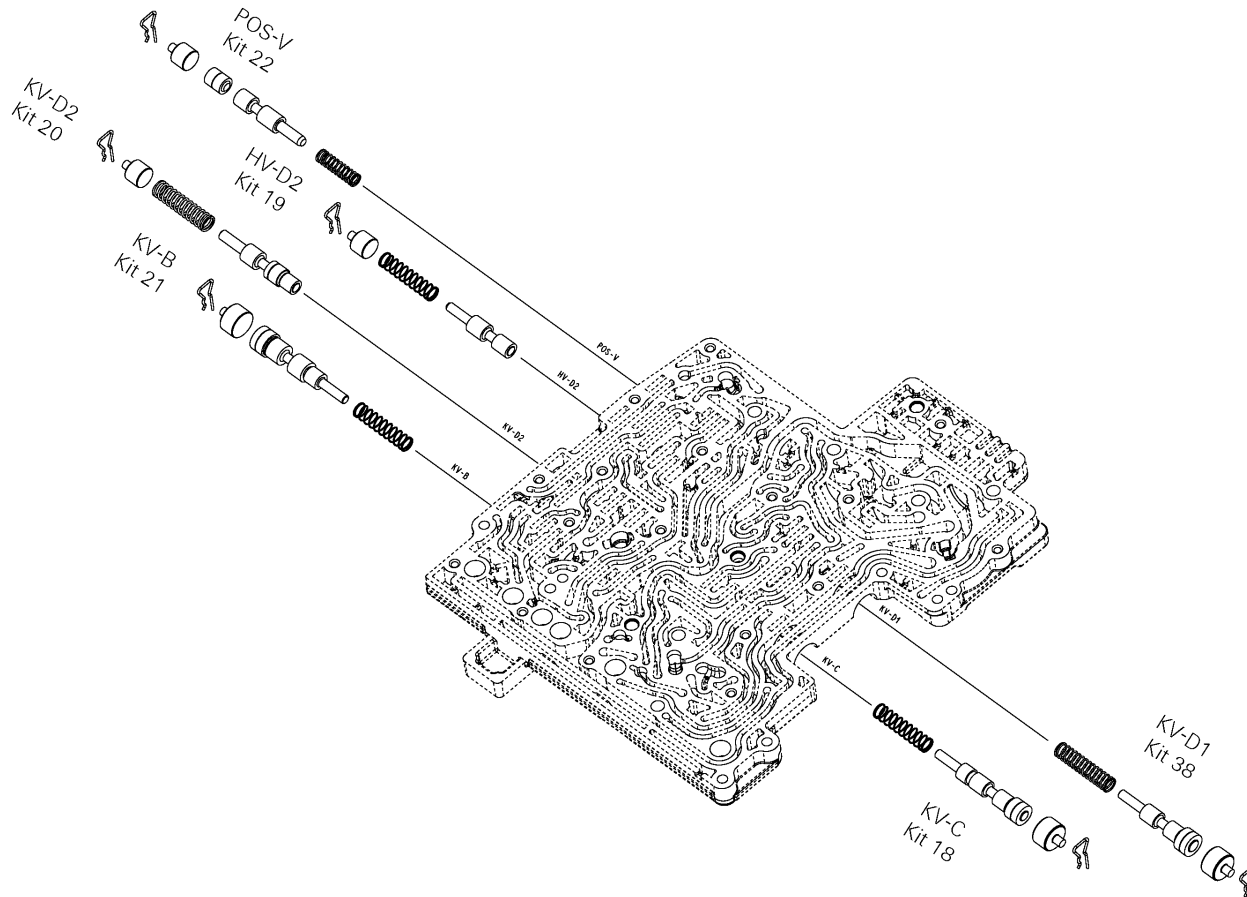

E20/2

Picture

Page 3 from 6

Material number: 1068.010.026

Picture: 1068_298_609-3

Material-assembly-group-no: 1068.298.514



6 HP 26 / ()
REPAIR KIT VALVE

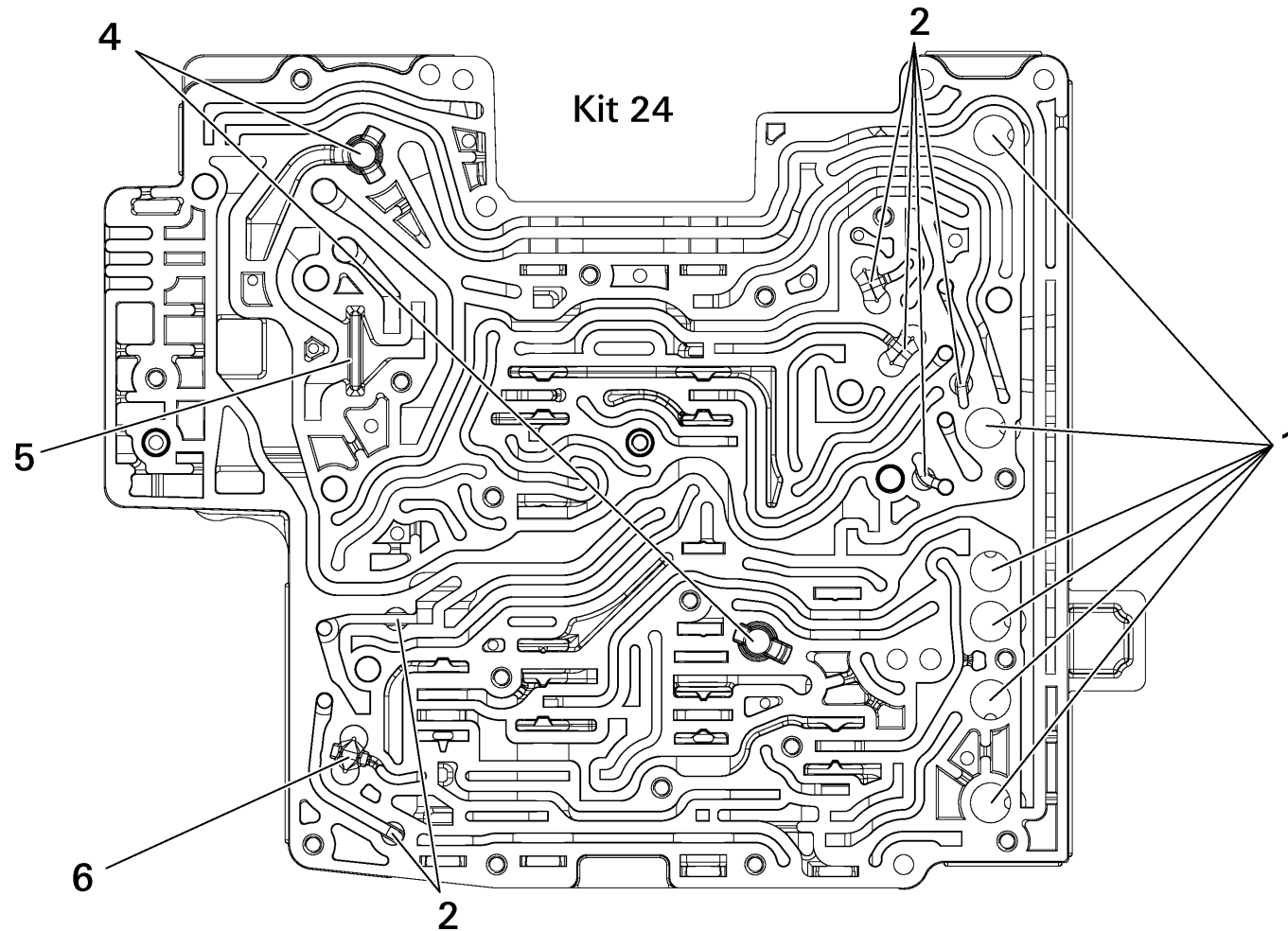

E20/2

Picture

Page 4 from 6

Material number: 1068.010.026

Picture: 1068_298_609-4

Material-assembly-group-no: 1068.298.514



6 HP 26 / ()
REPAIR KIT VALVE

1 - Kit 24

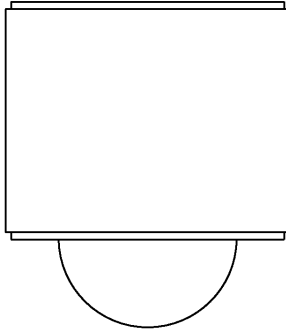

2 - Kit 24

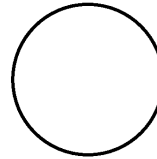

6 - Kit 24

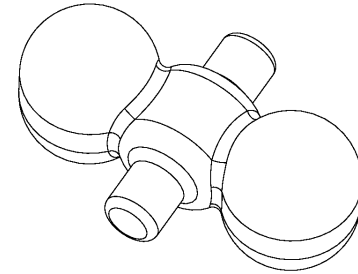

4 - Kit 24

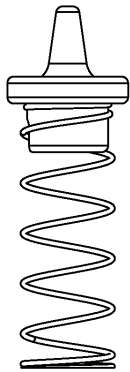

5 - Kit 24

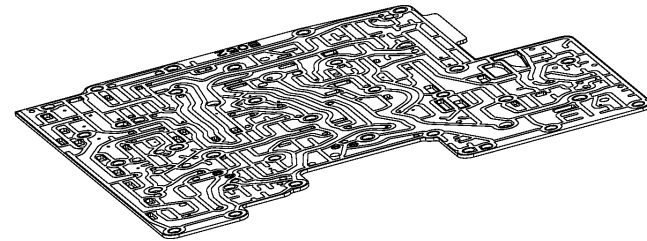
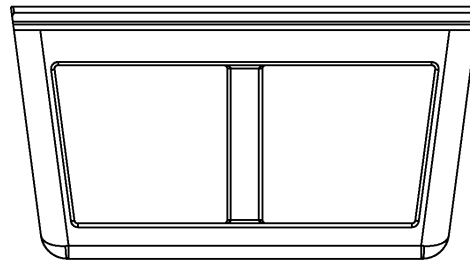

ET Zwischenblech

E20/2

Picture

Page 5 from 6

Material number: 1068.010.026

Picture: 114.D4.01-1

Material-assembly-group-no: 1068.298.514



6 HP 26 / ()
REPAIR KIT VALVE

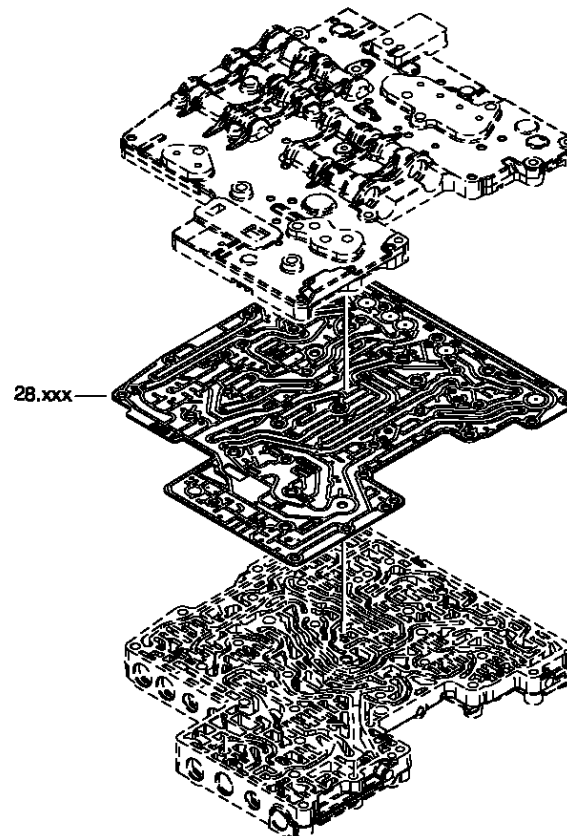

6 HP xx

Picture

Page 6 from 6

Material number: 1068.010.026

Picture: 114.G6.01-1

Material-assembly-group-no: 1068.298.514



6 HP 26 / ()
REPAIR KIT VALVE

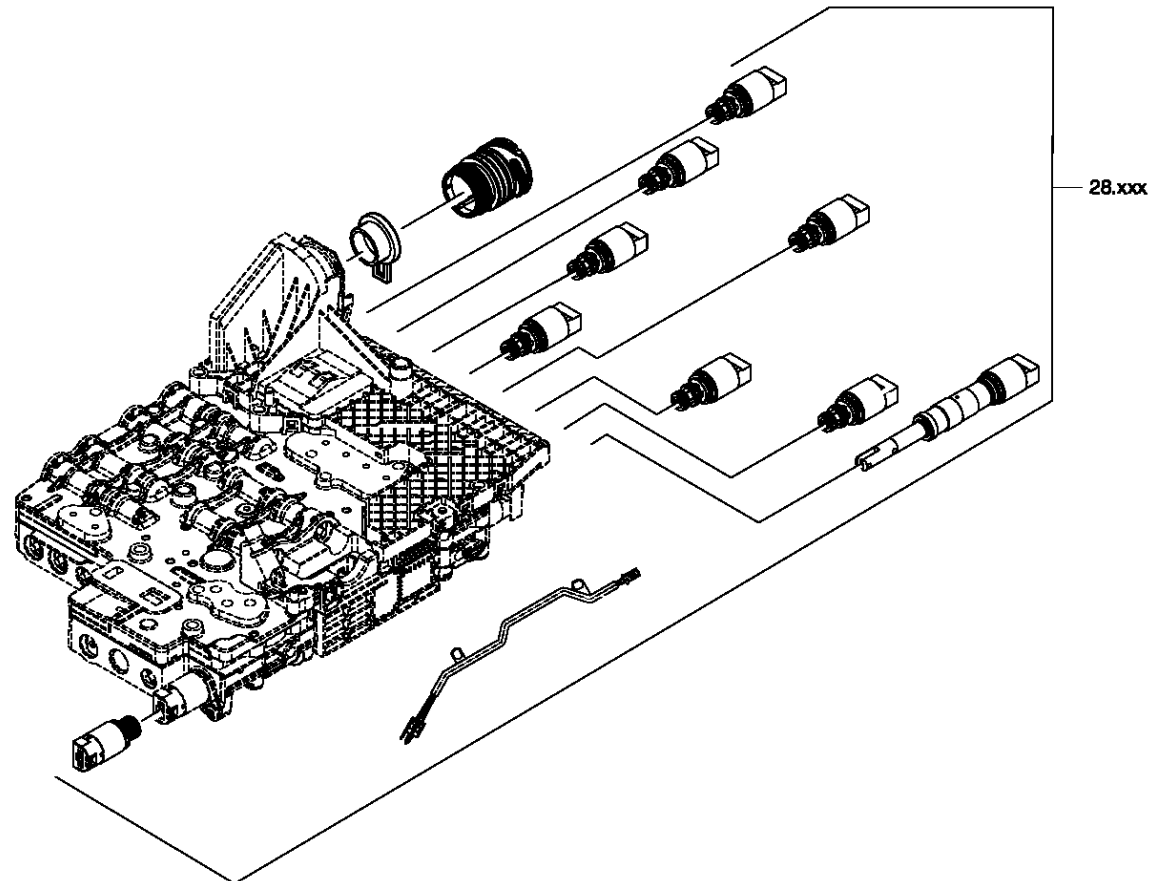

6 HP xx
E-Sch.

Picture

Page 2 from 6

Material number: 1068.010.026

Picture: 1068_298_609-2

Material-assembly-group-no: 1068.298.516



6 HP 26 / ()
REPAIR KIT VALVE

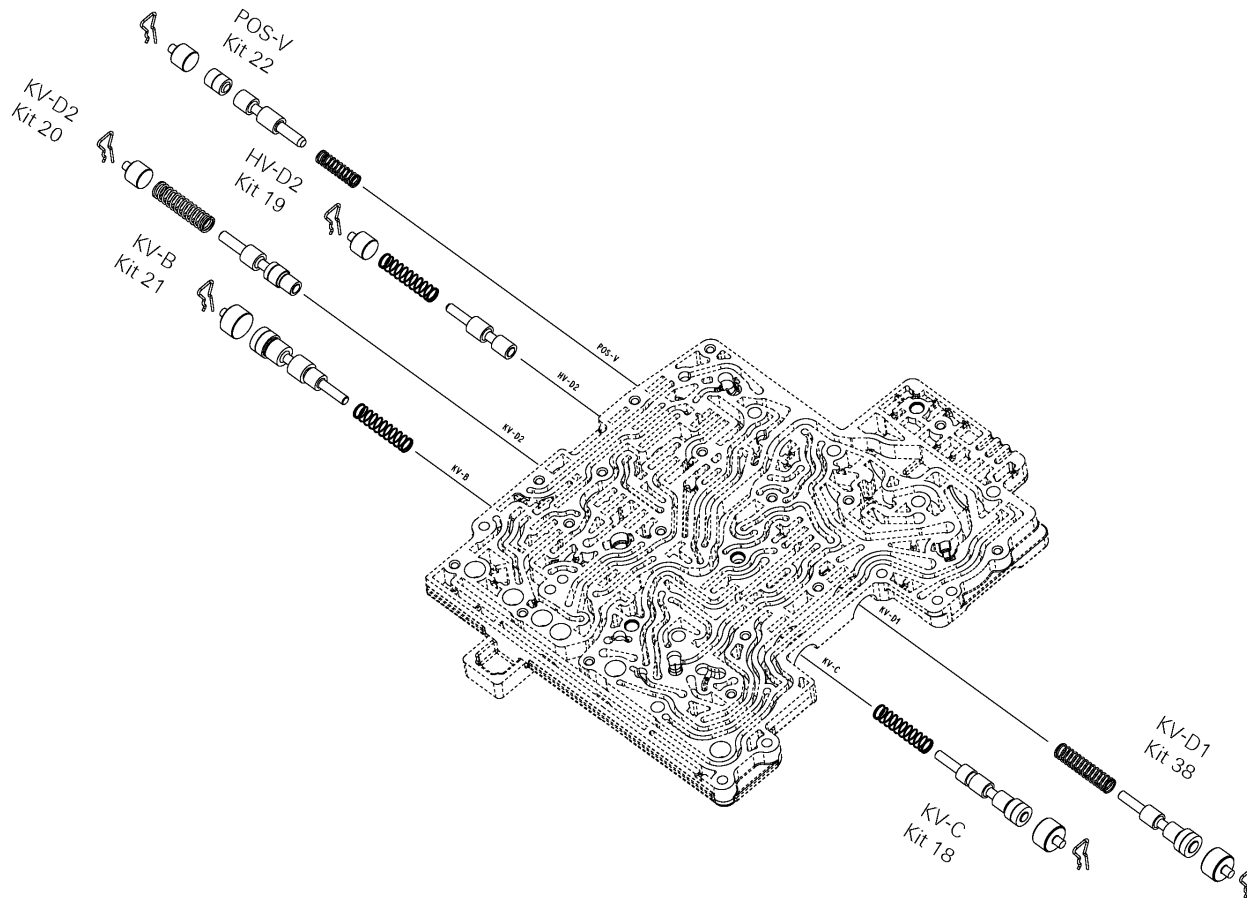

E20/2

Picture

Page 3 from 6

Material number: 1068.010.026

Picture: 1068_298_609-3

Material-assembly-group-no: 1068.298.516



6 HP 26 / ()
REPAIR KIT VALVE

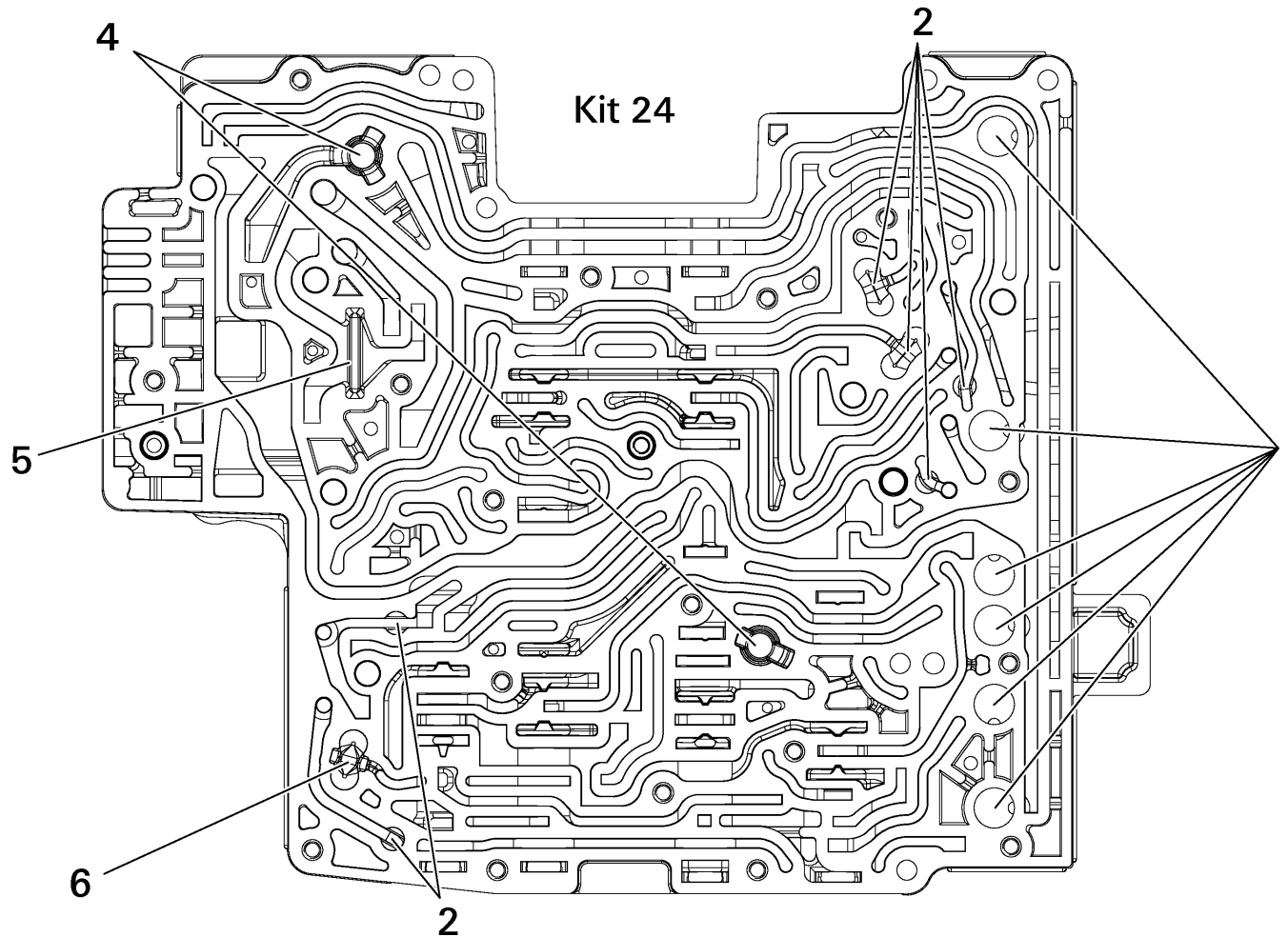

E20/2

Picture

Page 4 from 6

Material number: 1068.010.026

Picture: 1068_298_609-4

Material-assembly-group-no: 1068.298.516



6 HP 26 / ()
REPAIR KIT VALVE

1 - Kit 24

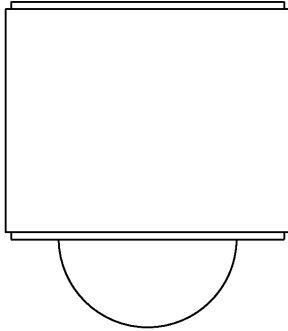

2 - Kit 24

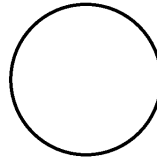

6 - Kit 24

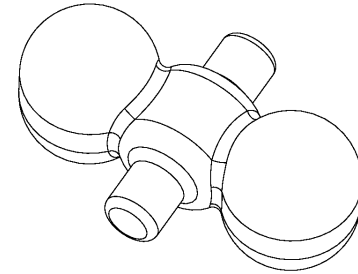

4 - Kit 24

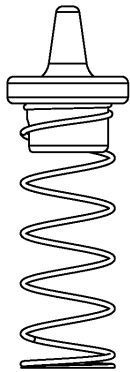

5 - Kit 24

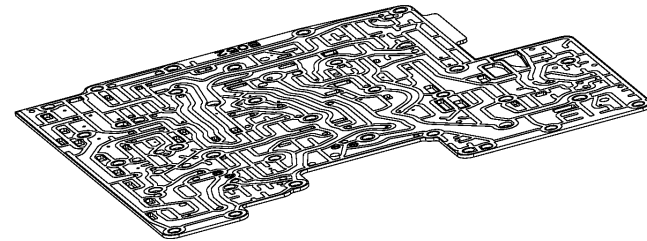
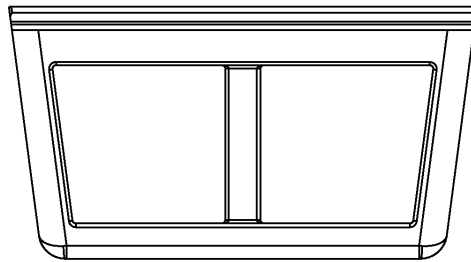

ET Zwischenblech

E20/2

Picture

Page 5 from 6

Material number: 1068.010.026

Picture: 114.D4.01-1

Material-assembly-group-no: 1068.298.516



6 HP 26 / ()
REPAIR KIT VALVE

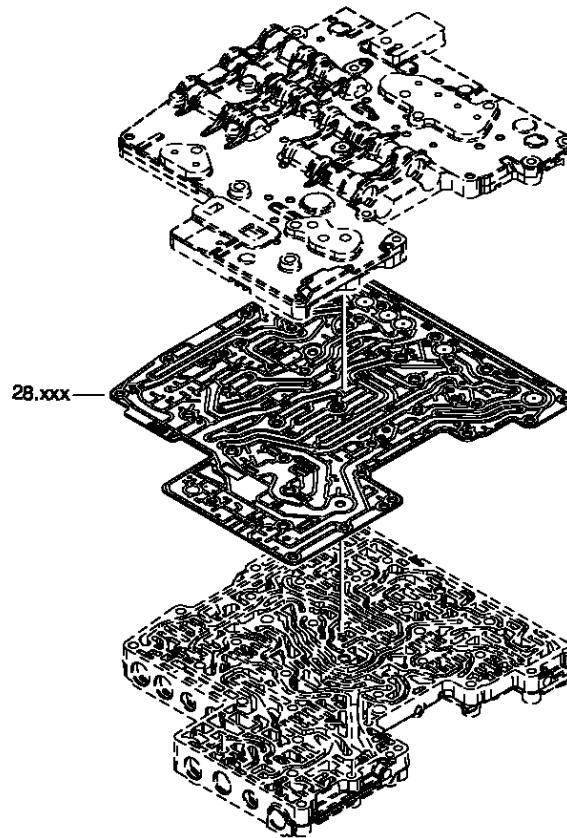

6 HP xx

Picture

Page 6 from 6

Material number: 1068.010.026

Picture: 114.G6.01-1

Material-assembly-group-no: 1068.298.516



6 HP 26 / ()
REPAIR KIT VALVE

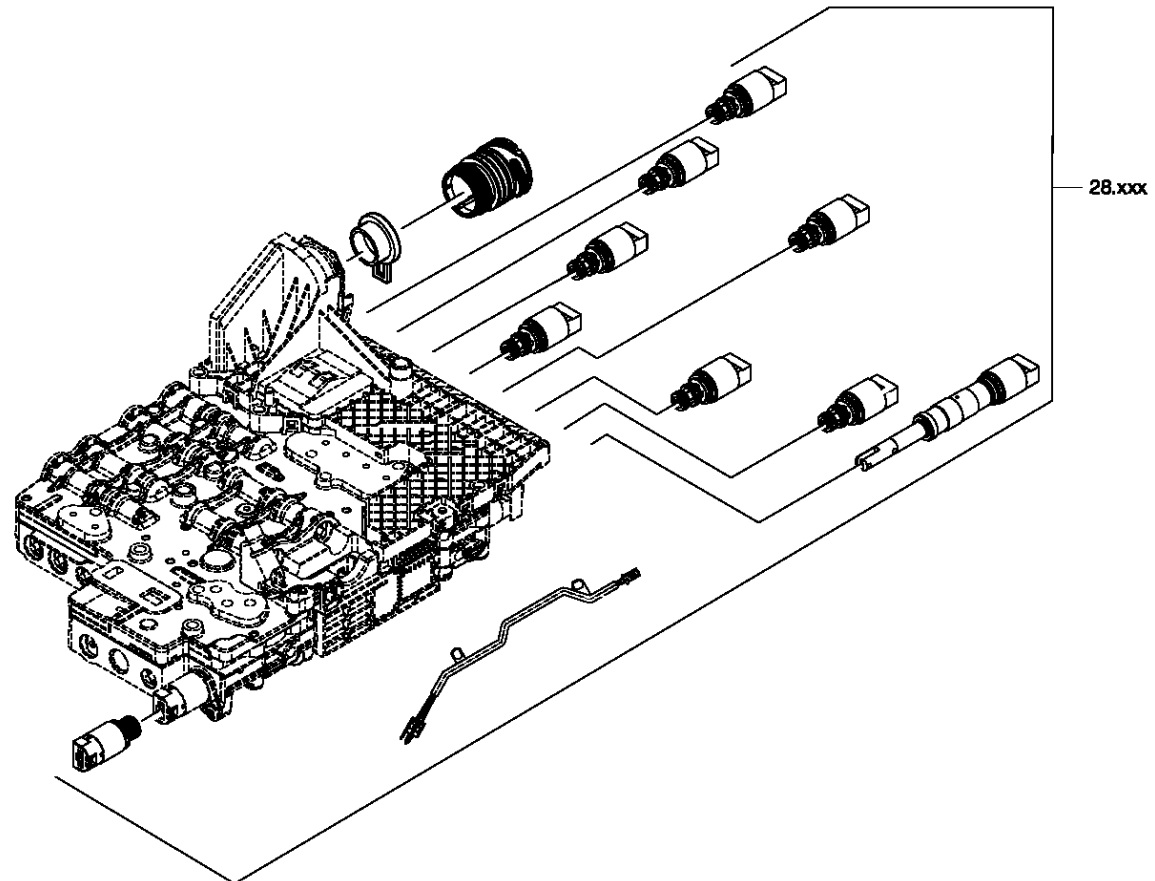

6 HP xx
E-Sch.

Picture

Page 2 from 6

Material number: 1068.010.026

Picture: 1068_298_609-2

Material-assembly-group-no: 1068.298.518



6 HP 26 / ()
REPAIR KIT VALVE

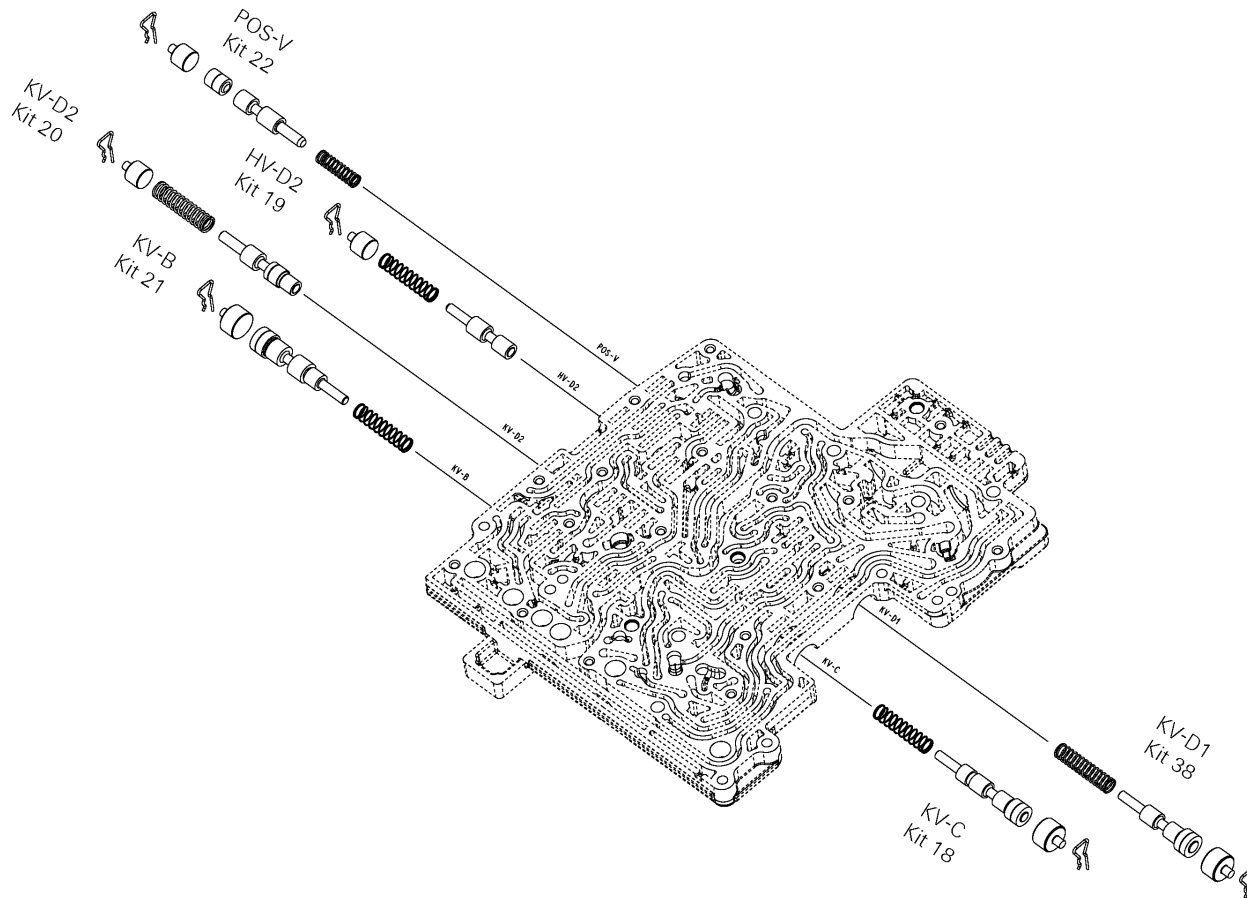

E20/2

Picture

Page 3 from 6

Material number: 1068.010.026

Picture: 1068_298_609-3

Material-assembly-group-no: 1068.298.518



6 HP 26 / ()
REPAIR KIT VALVE

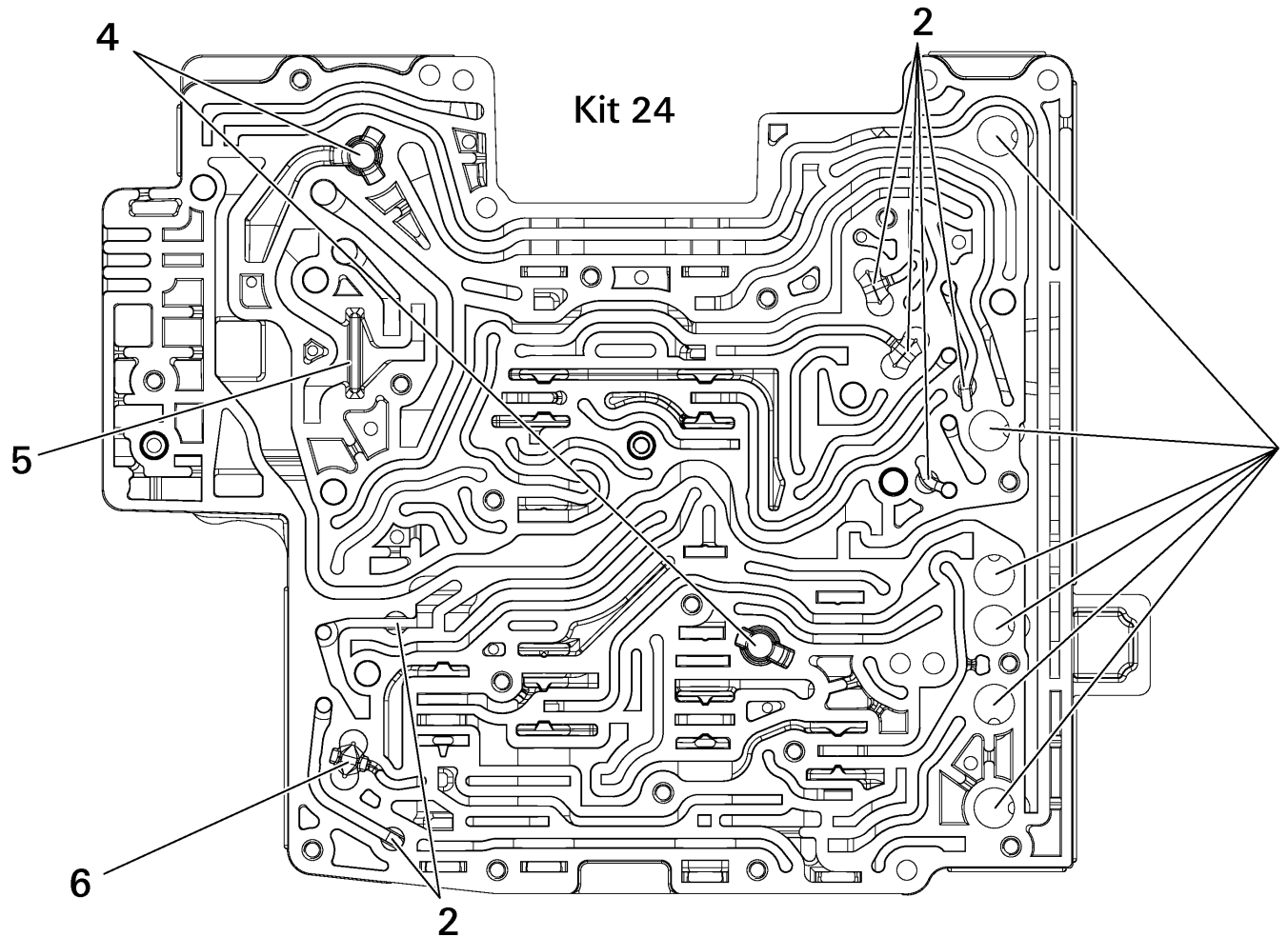

E20/2

Picture

Page 4 from 6

Material number: 1068.010.026

Picture: 1068_298_609-4

Material-assembly-group-no: 1068.298.518



6 HP 26 / ()
REPAIR KIT VALVE

1 - Kit 24

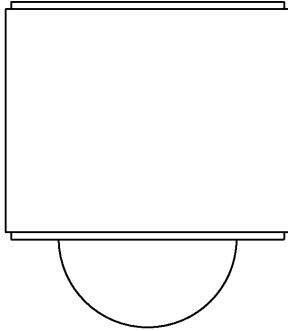

2 - Kit 24

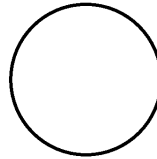

6 - Kit 24

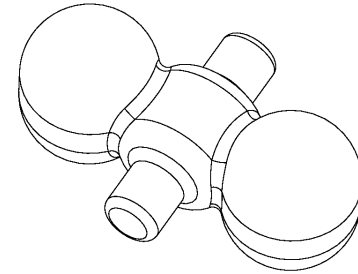

4 - Kit 24

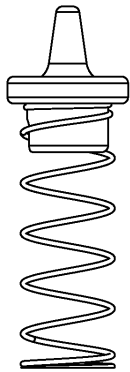

5 - Kit 24

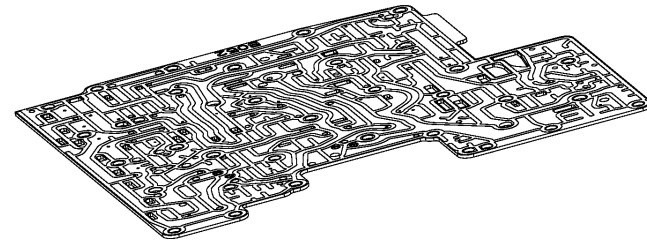
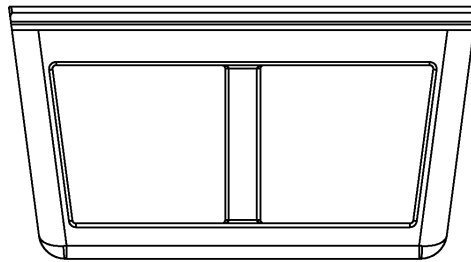

ET Zwischenblech

E20/2

Picture

Page 5 from 6

Material number: 1068.010.026

Picture: 114.D4.01-1

Material-assembly-group-no: 1068.298.518



6 HP 26 / ()
REPAIR KIT VALVE

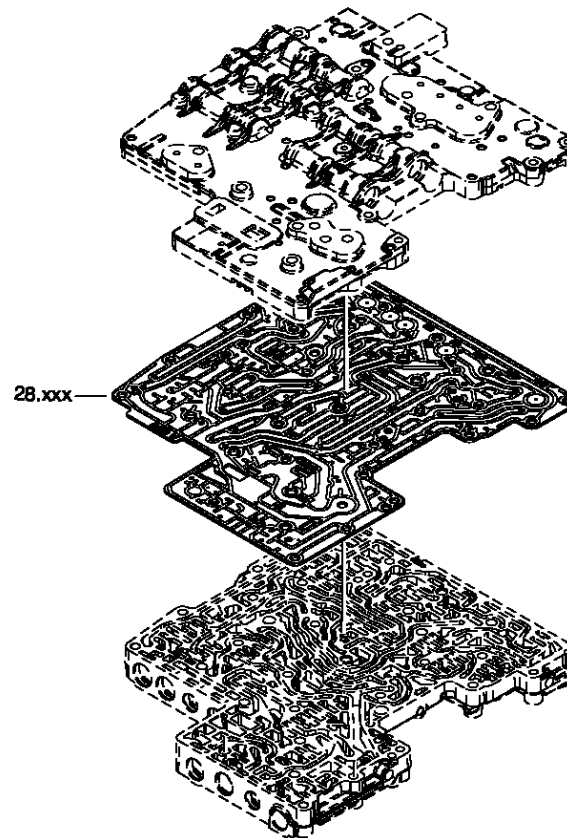

6 HP xx

Picture

Page 6 from 6

Material number: 1068.010.026

Picture: 114.G6.01-1

Material-assembly-group-no: 1068.298.518



6 HP 26 / ()
REPAIR KIT VALVE

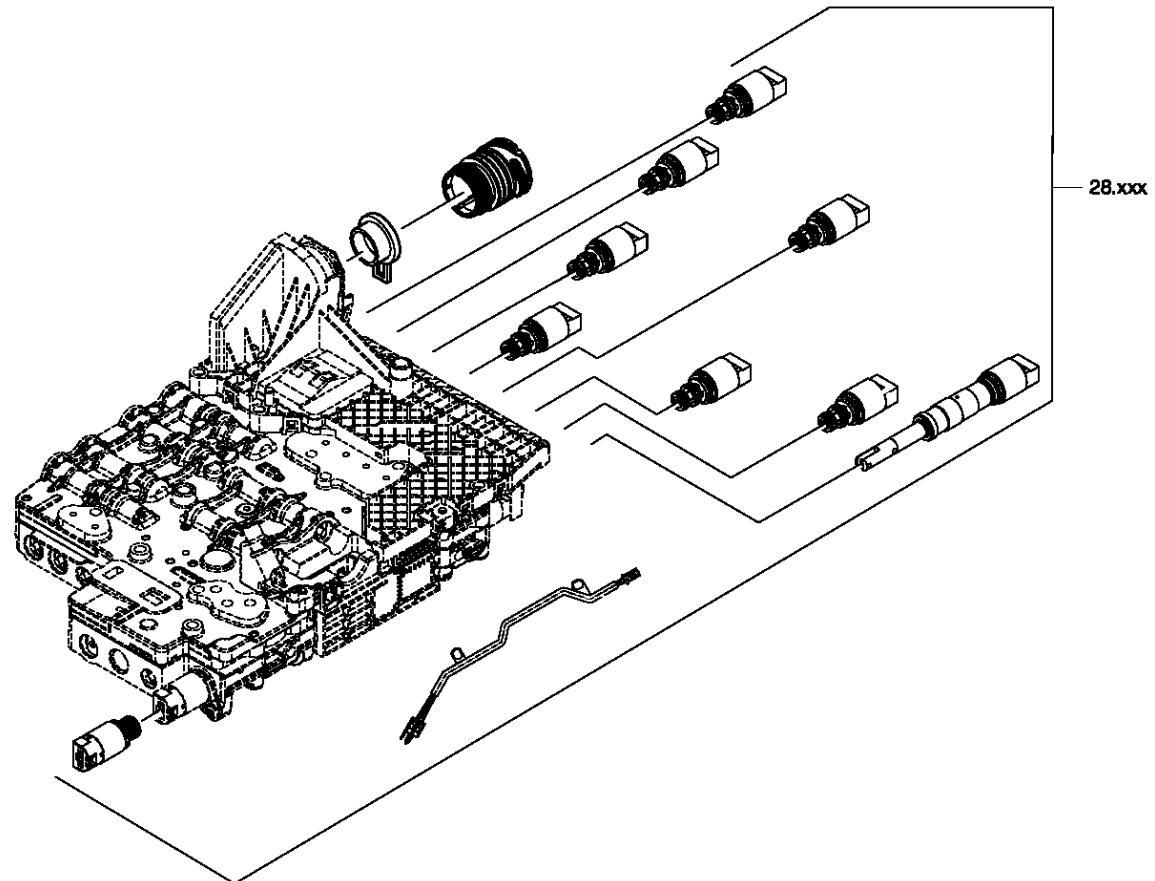

6 HP xx
E-Sch.

Picture

Page 2 from 6

Material number: 1068.010.026

Picture: 1068_298_609-2

Material-assembly-group-no: 1068.298.519



6 HP 26 / ()
REPAIR KIT VALVE

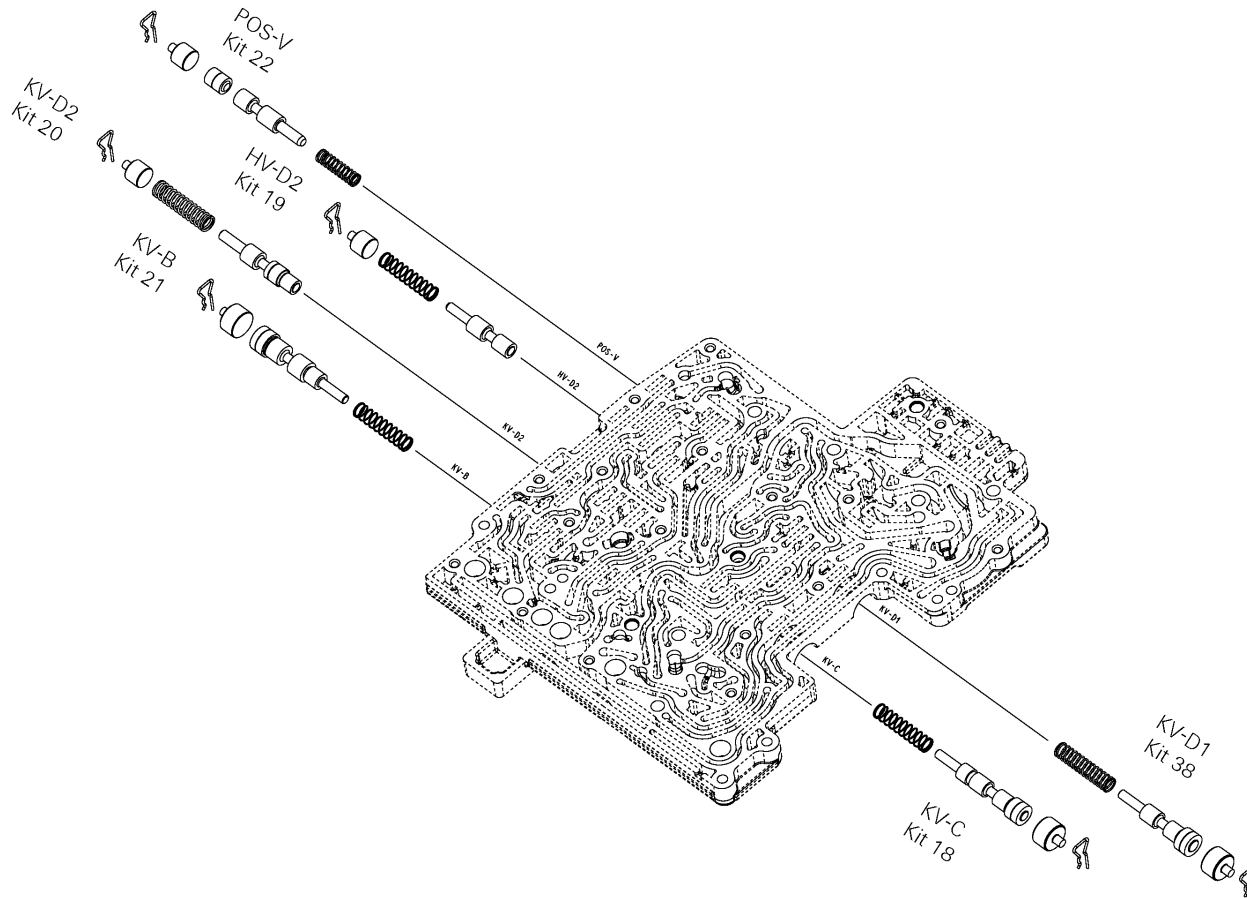

E20/2

Picture

Page 3 from 6

Material number: 1068.010.026

Picture: 1068_298_609-3

Material-assembly-group-no: 1068.298.519



6 HP 26 / ()
REPAIR KIT VALVE

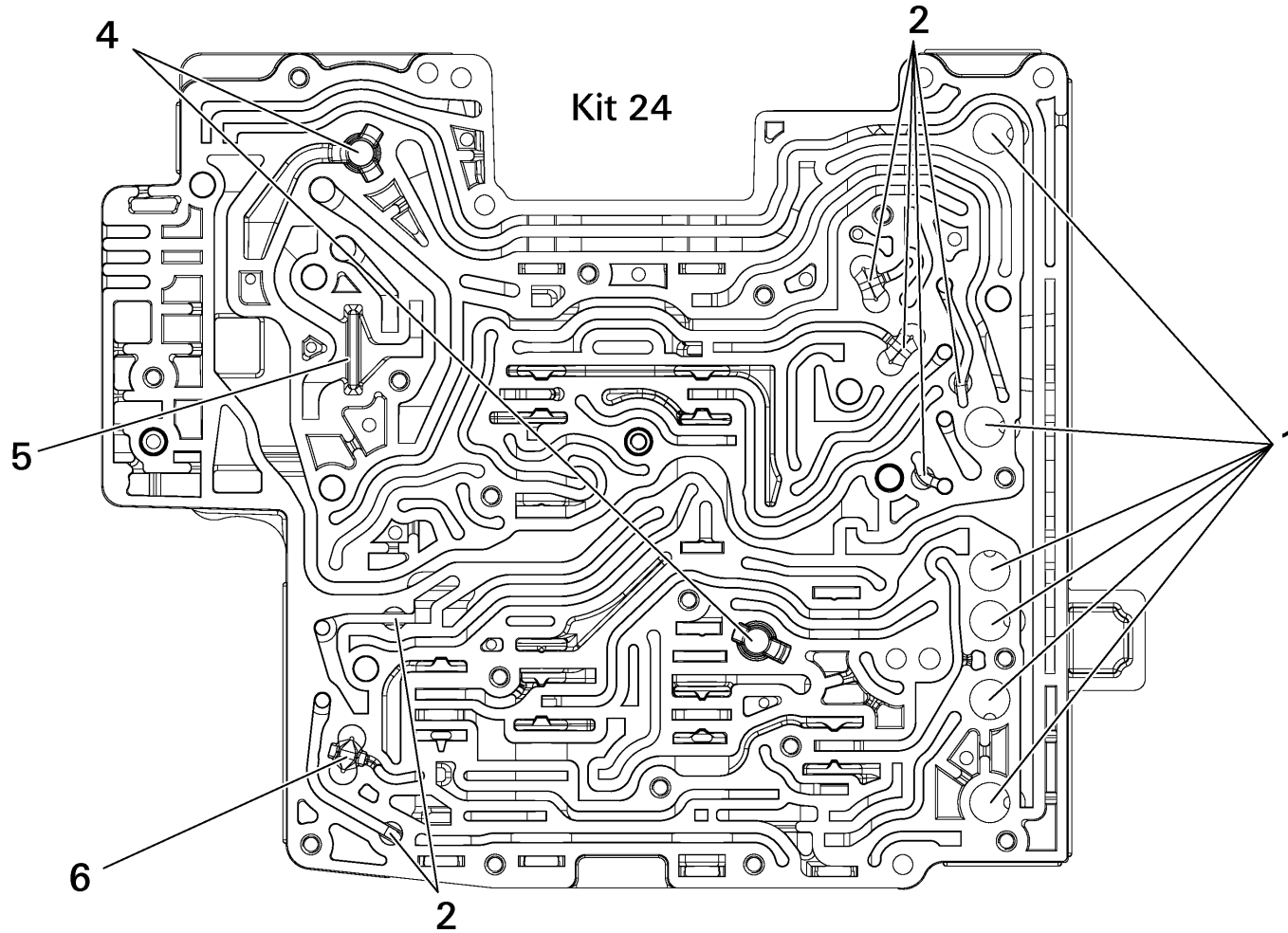

E20/2

Picture

Page 4 from 6

Material number: 1068.010.026

Picture: 1068_298_609-4

Material-assembly-group-no: 1068.298.519



6 HP 26 / ()
REPAIR KIT VALVE

1 - Kit 24

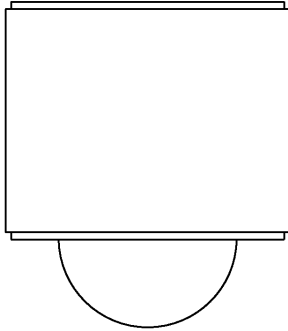

2 - Kit 24

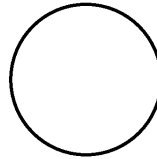

6 - Kit 24

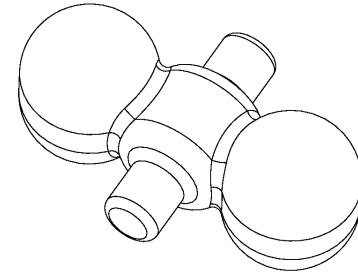

4 - Kit 24

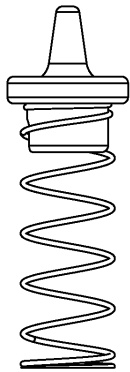

5 - Kit 24

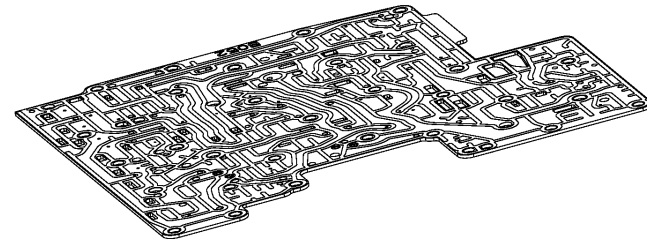
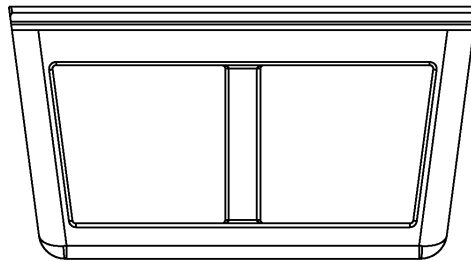

ET Zwischenblech

E20/2

Picture

Page 5 from 6

Material number: 1068.010.026

Picture: 114.D4.01-1

Material-assembly-group-no: 1068.298.519



6 HP 26 / ()
REPAIR KIT VALVE

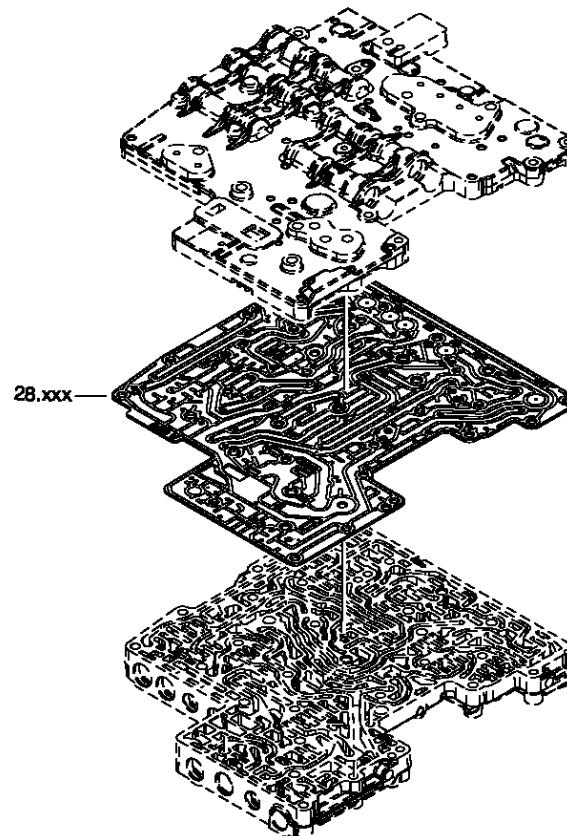

6 HP xx

Picture

Page 6 from 6

Material number: 1068.010.026

Picture: 114.G6.01-1

Material-assembly-group-no: 1068.298.519



6 HP 26 / ()
REPAIR KIT VALVE

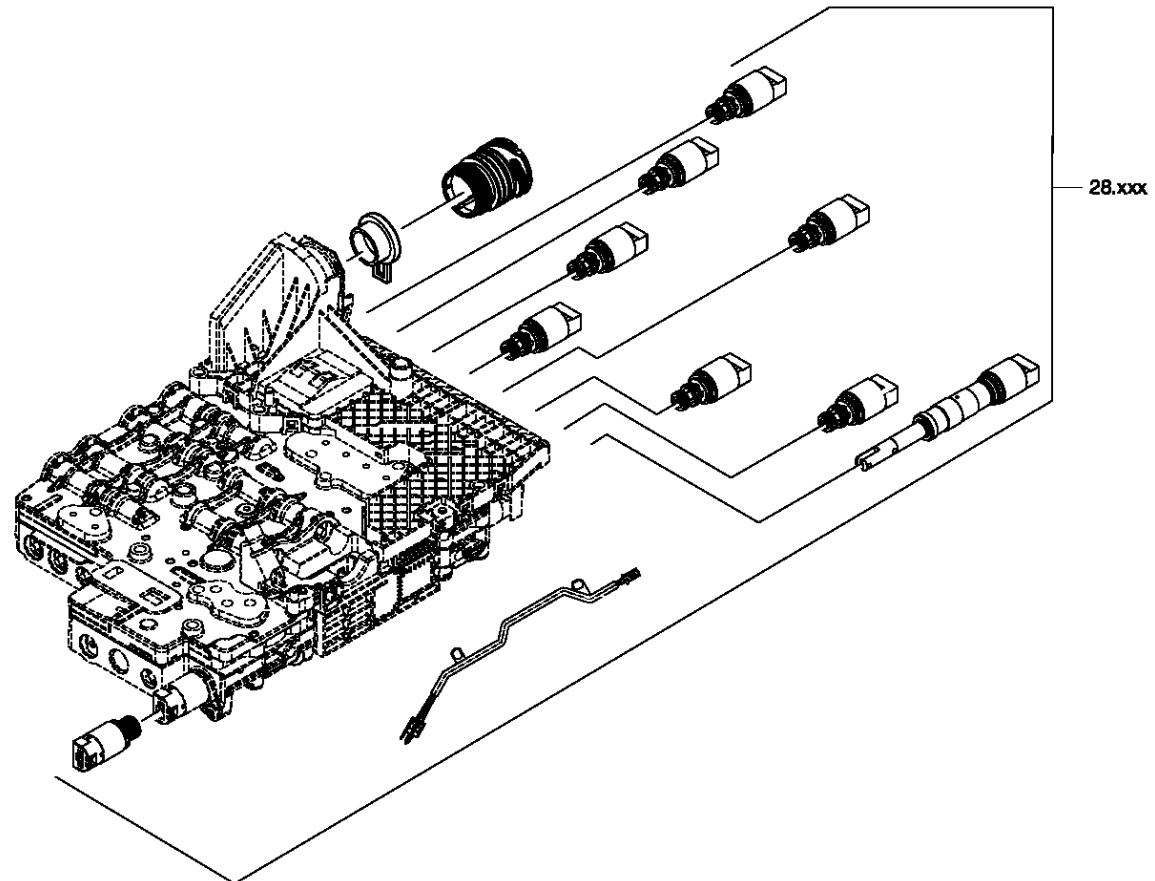

6 HP xx
E-Sch.

Picture

Page 1 from 6

Material number: 1068.010.026

Picture: 1068_298_609-1

Material-assembly-group-no: 1068.298.520



6 HP 26 / ()
REPAIR KIT VALVE

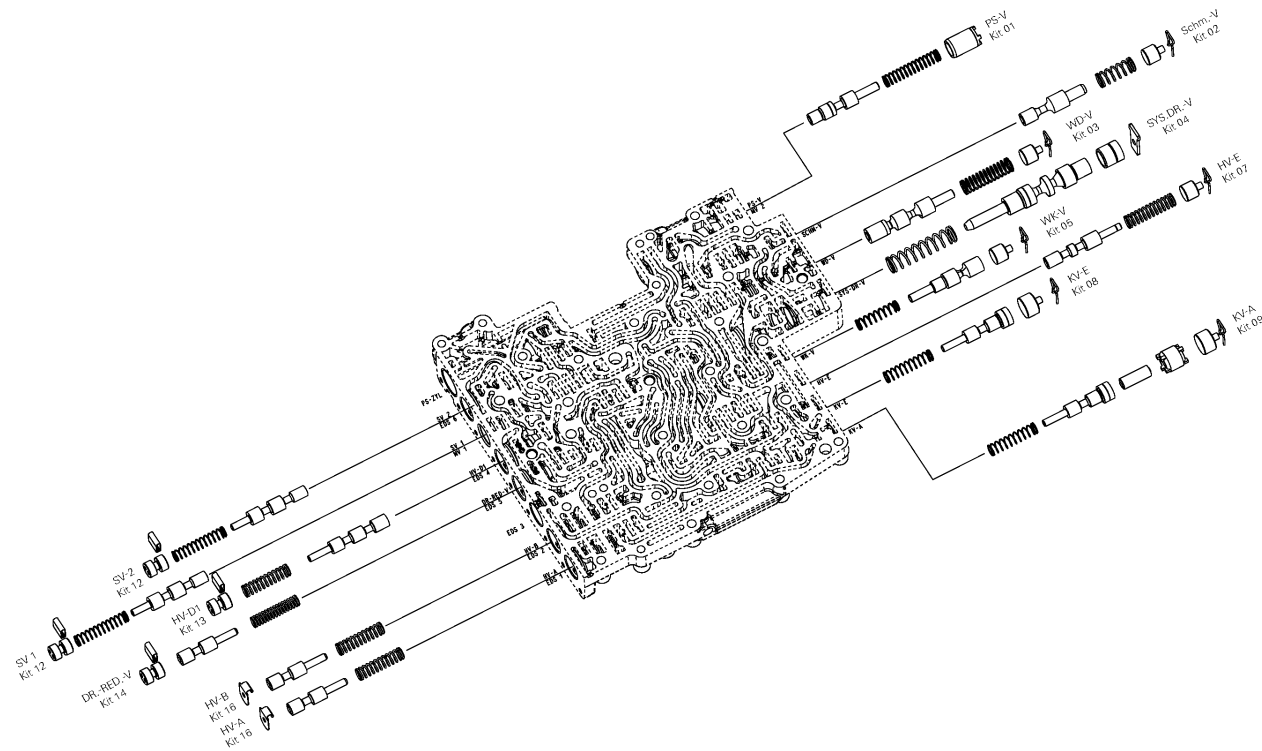

E20/2

Picture

Page 2 from 6

Material number: 1068.010.026

Picture: 1068_298_609-2

Material-assembly-group-no: 1068.298.520



6 HP 26 / ()
REPAIR KIT VALVE

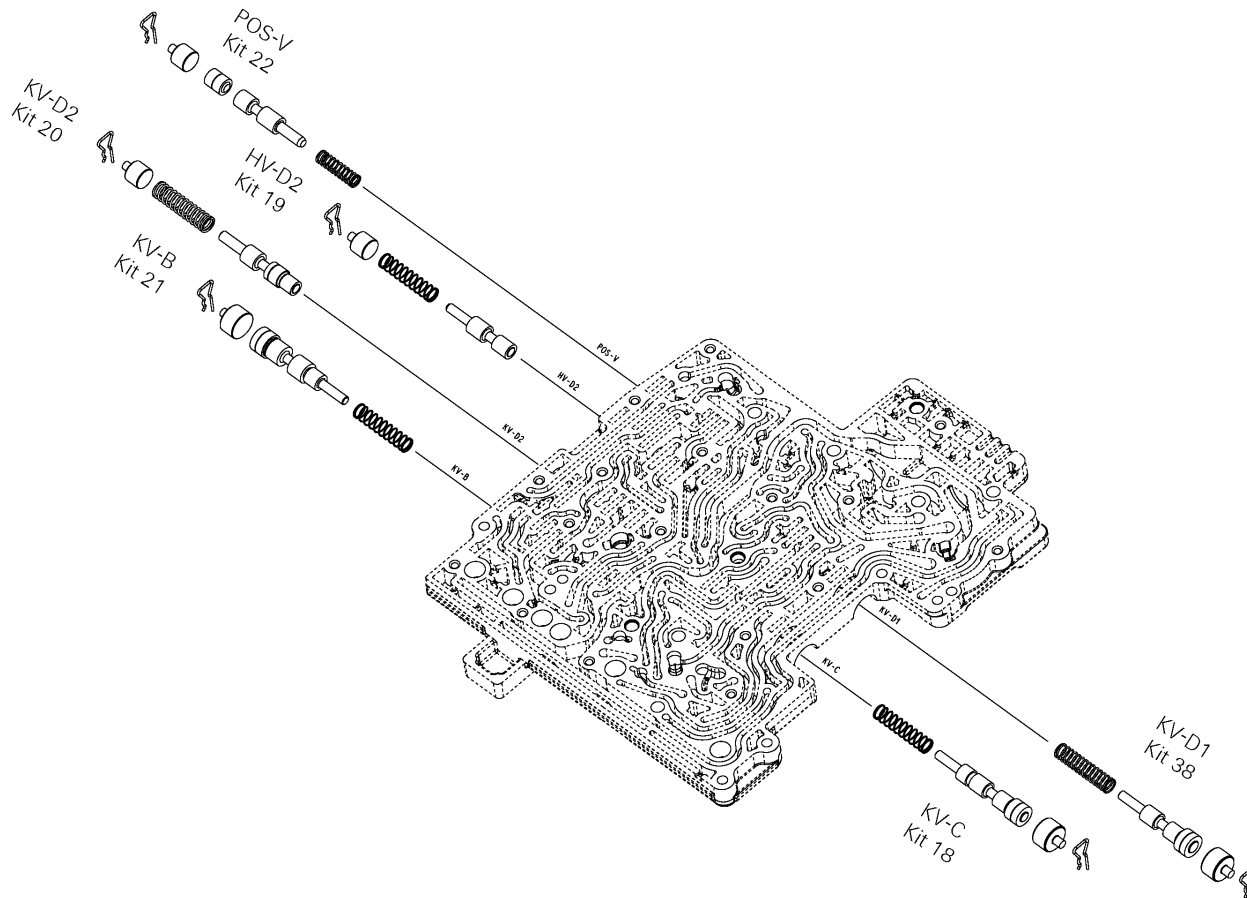

E20/2

Picture

Page 3 from 6

Material number: 1068.010.026

Picture: 1068_298_609-3

Material-assembly-group-no: 1068.298.520



6 HP 26 / ()
REPAIR KIT VALVE

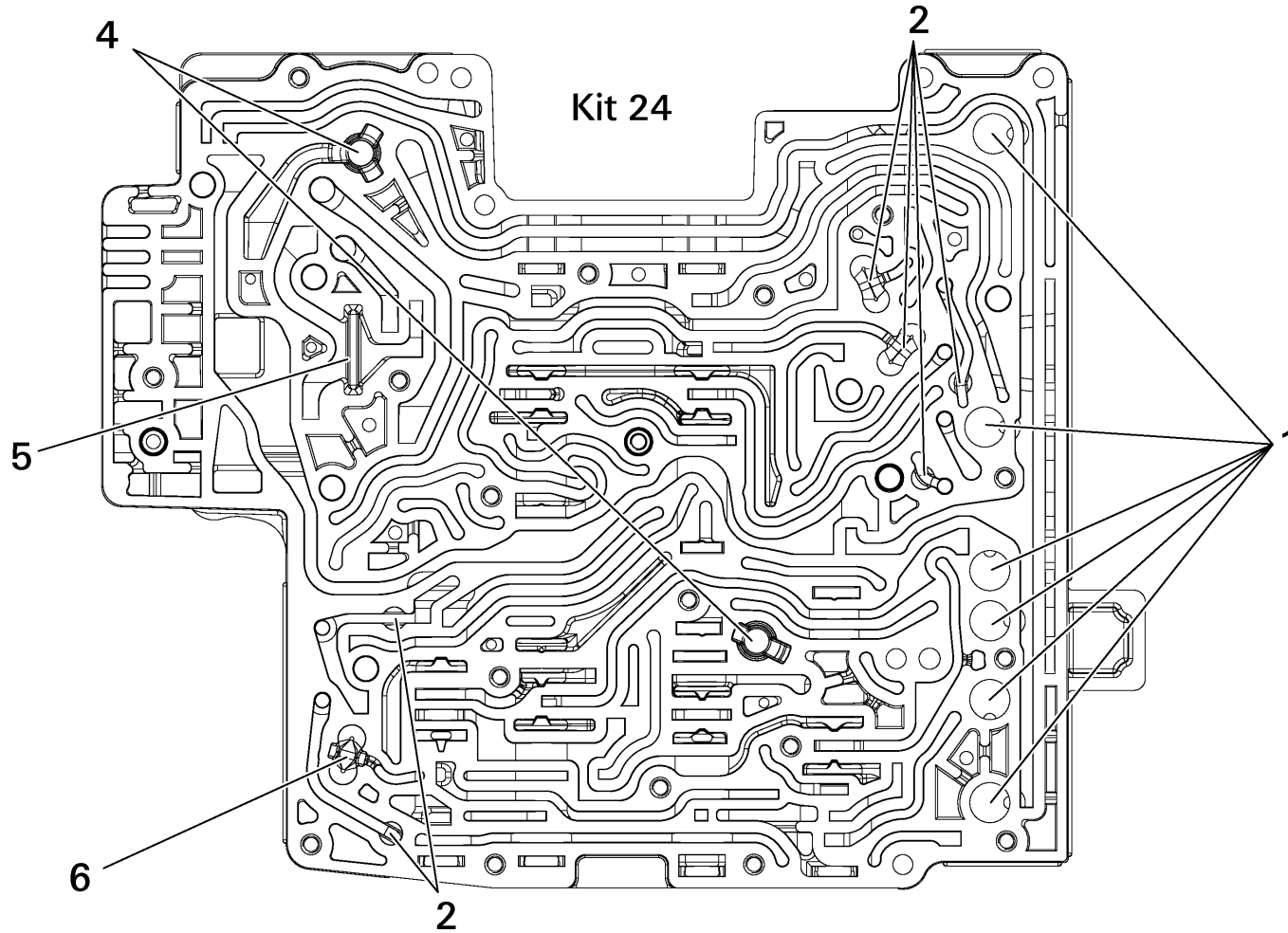

E20/2

Picture

Page 4 from 6

Material number: 1068.010.026

Picture: 1068_298_609-4

Material-assembly-group-no: 1068.298.520



6 HP 26 / ()
REPAIR KIT VALVE

1 - Kit 24

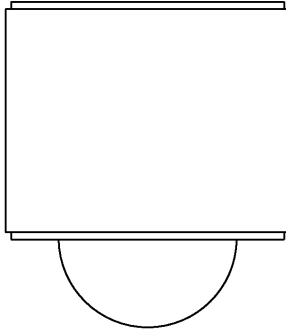

2 - Kit 24

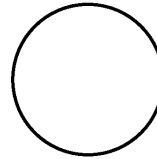

6 - Kit 24

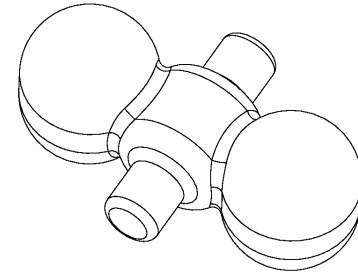

4 - Kit 24

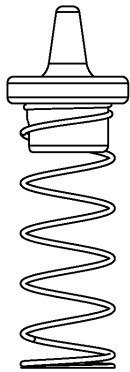

5 - Kit 24

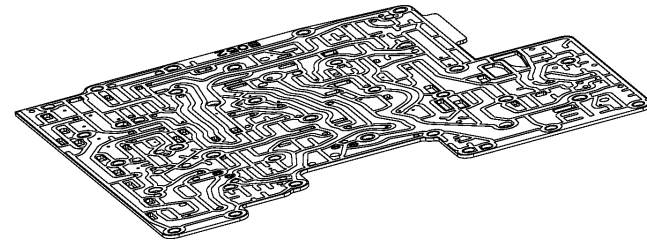
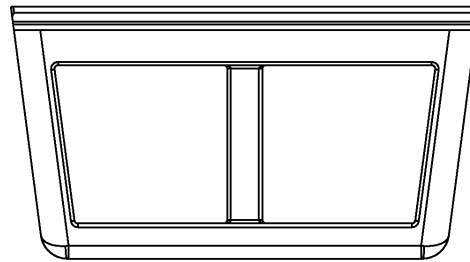

ET Zwischenblech

E20/2

Picture

Page 5 from 6

Material number: 1068.010.026

Picture: 114.D4.01-1

Material-assembly-group-no: 1068.298.520



6 HP 26 / ()
REPAIR KIT VALVE

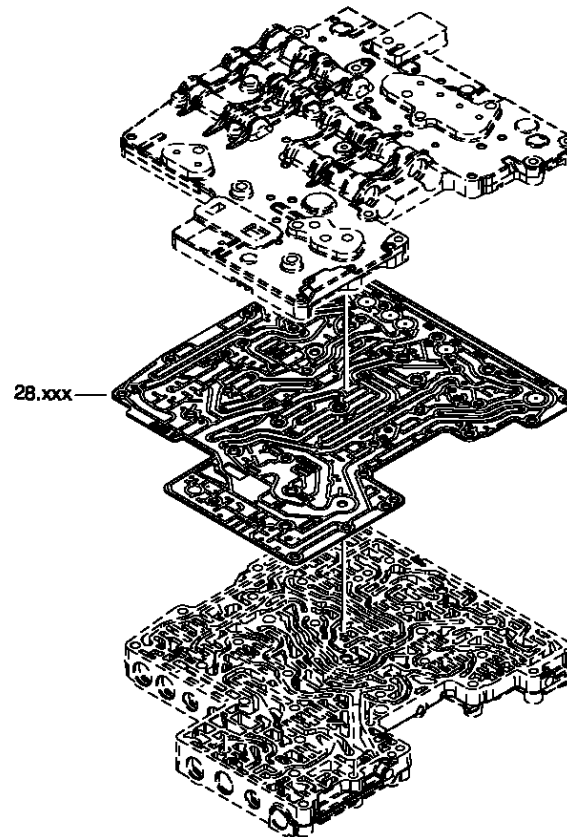

6 HP xx

Picture

Page 6 from 6

Material number: 1068.010.026

Picture: 114.G6.01-1

Material-assembly-group-no: 1068.298.520



6 HP 26 / ()
REPAIR KIT VALVE

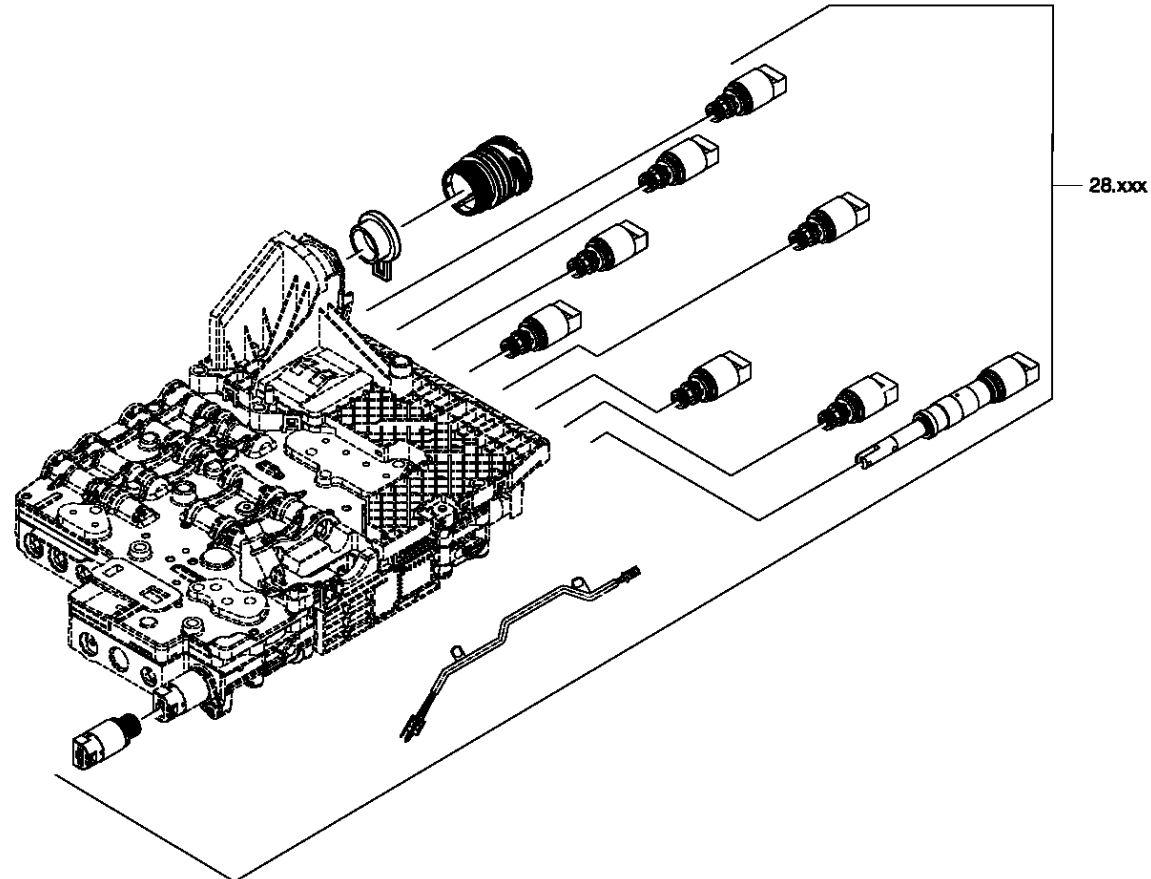

6 HP xx
E-Sch.

Picture

Page 2 from 6

Material number: 1068.010.026

Picture: 1068_298_609-2

Material-assembly-group-no: 1068.298.521



6 HP 26 / ()
REPAIR KIT VALVE

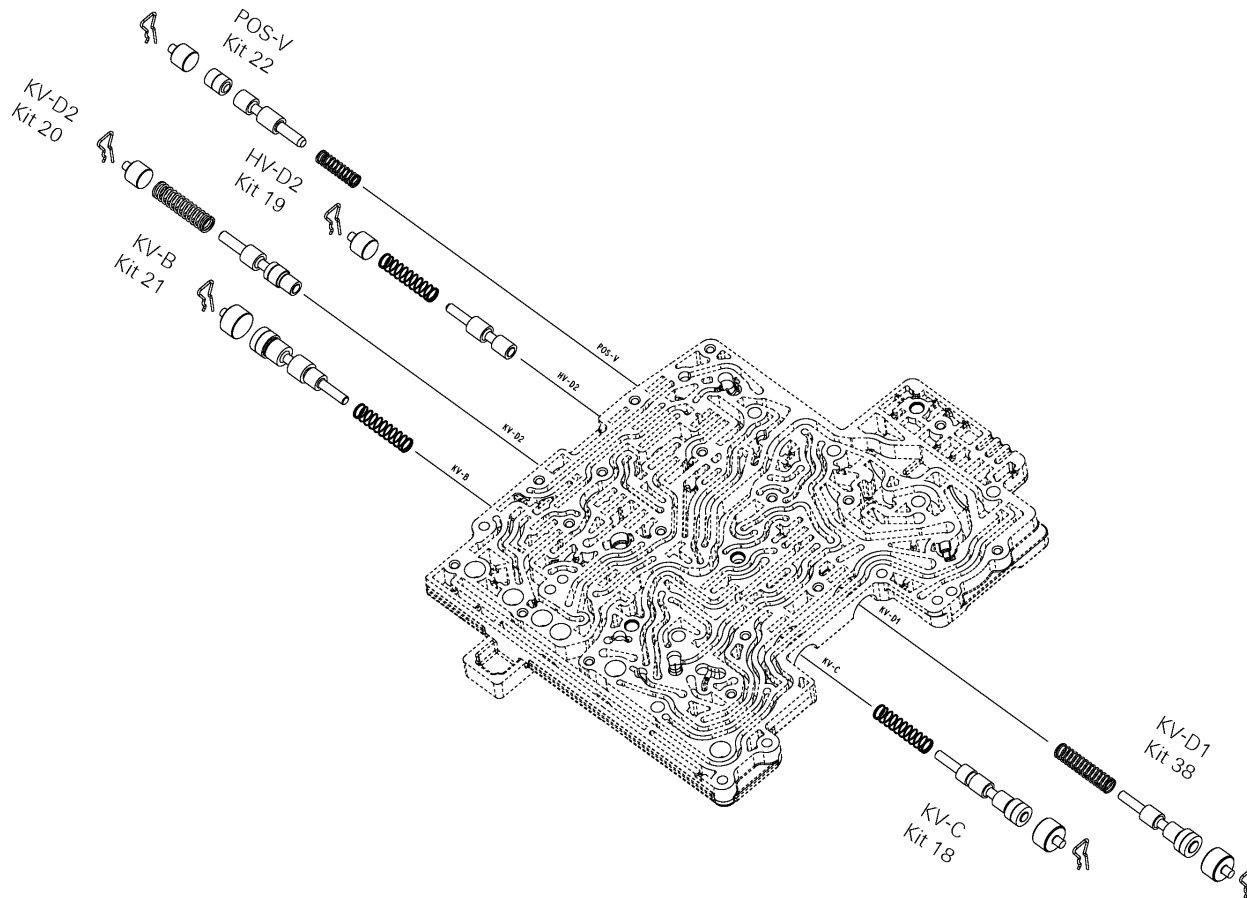

E20/2

Picture

Page 3 from 6

Material number: 1068.010.026

Picture: 1068_298_609-3

Material-assembly-group-no: 1068.298.521



6 HP 26 / ()
REPAIR KIT VALVE

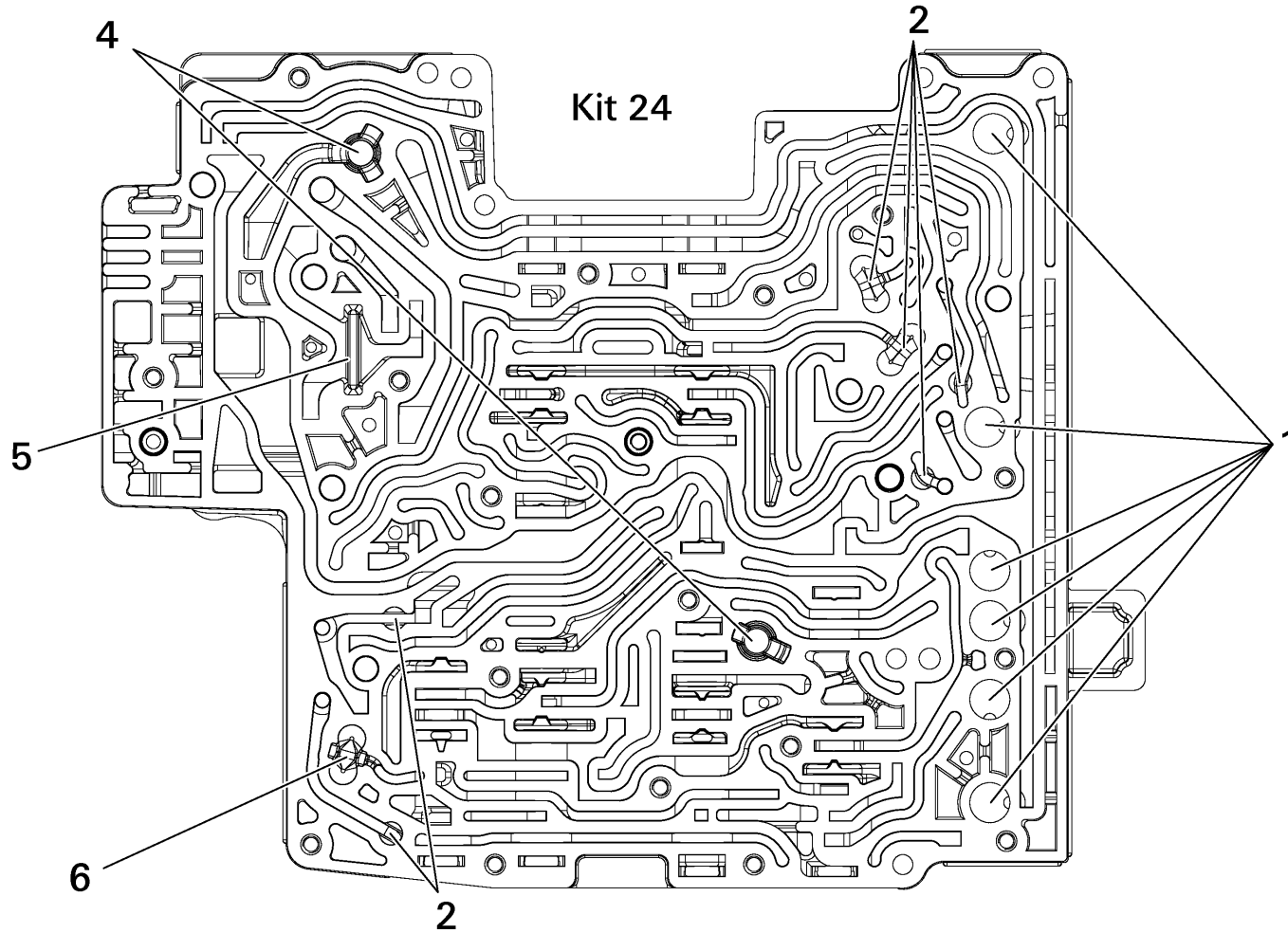

E20/2

Picture

Page 4 from 6

Material number: 1068.010.026

Picture: 1068_298_609-4

Material-assembly-group-no: 1068.298.521



6 HP 26 / ()
REPAIR KIT VALVE

1 - Kit 24

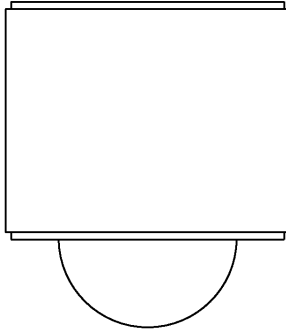

2 - Kit 24

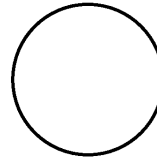

6 - Kit 24

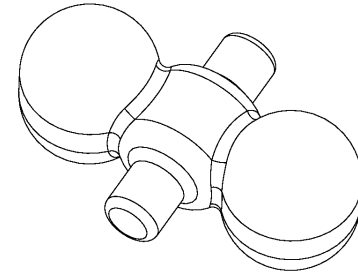

4 - Kit 24

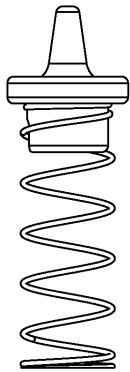

5 - Kit 24

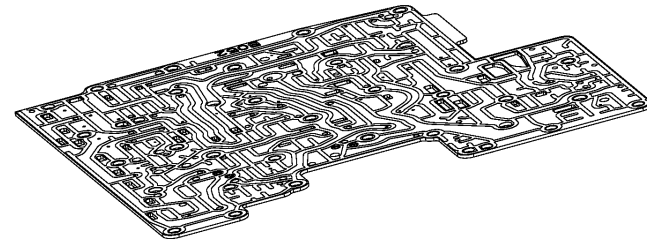
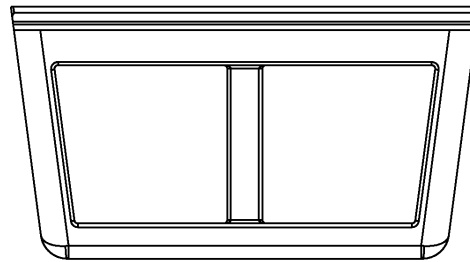

ET Zwischenblech

E20/2

Picture

Page 5 from 6

Material number: 1068.010.026

Picture: 114.D4.01-1

Material-assembly-group-no: 1068.298.521



6 HP 26 / ()
REPAIR KIT VALVE

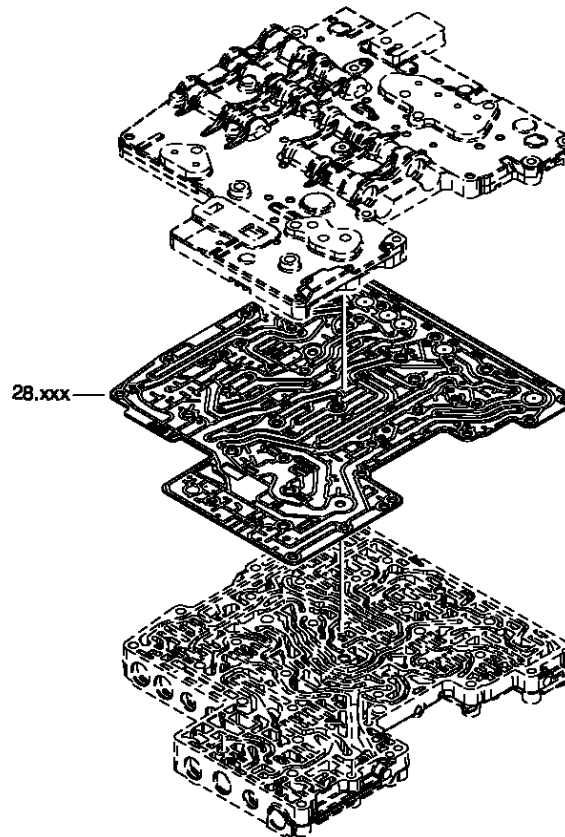

6 HP xx

Picture

Page 6 from 6

Material number: 1068.010.026

Picture: 114.G6.01-1

Material-assembly-group-no: 1068.298.521



6 HP 26 / ()
REPAIR KIT VALVE

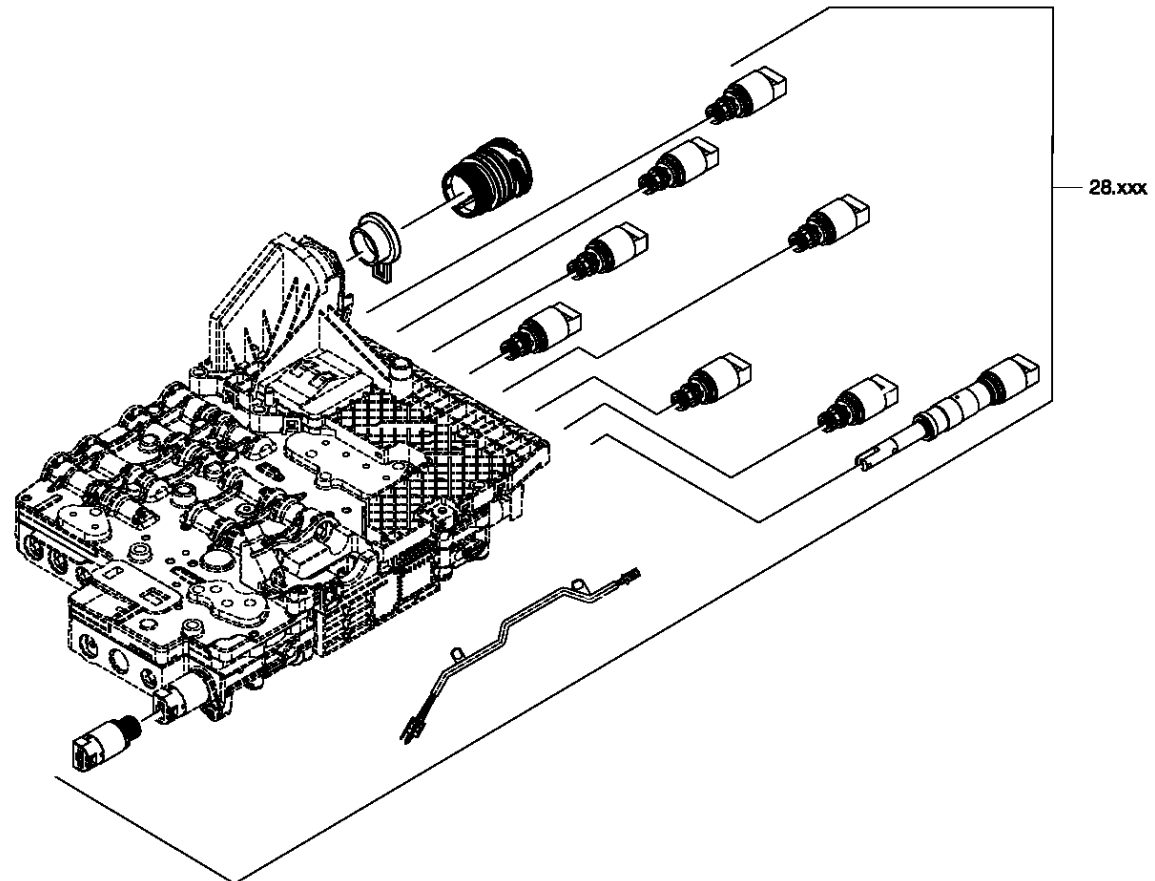

6 HP xx
E-Sch.

Picture

Page 2 from 6

Material number: 1068.010.026

Picture: 1068_298_609-2

Material-assembly-group-no: 1068.298.522



6 HP 26 / ()
REPAIR KIT VALVE

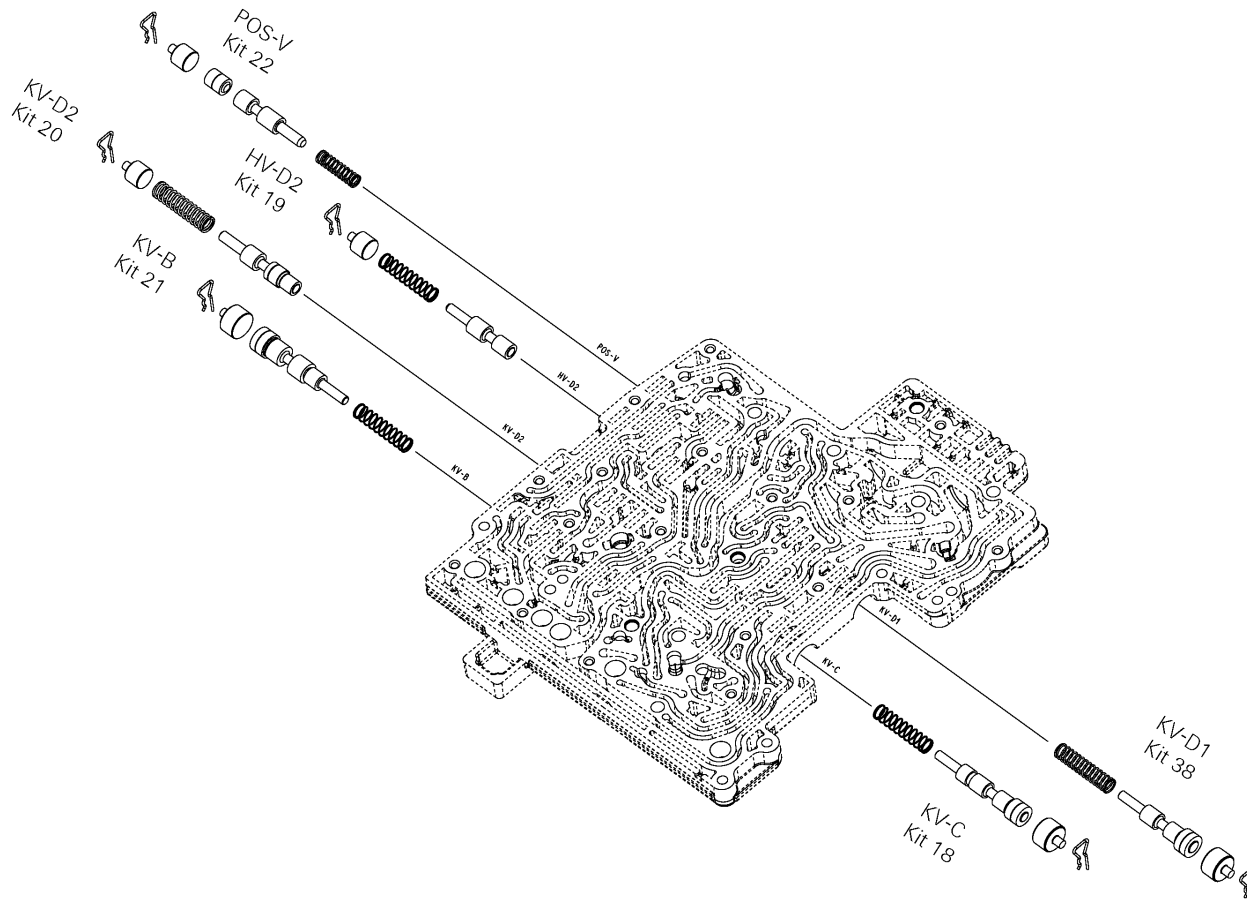

E20/2

Picture

Page 3 from 6

Material number: 1068.010.026

Picture: 1068_298_609-3

Material-assembly-group-no: 1068.298.522



6 HP 26 / ()
REPAIR KIT VALVE

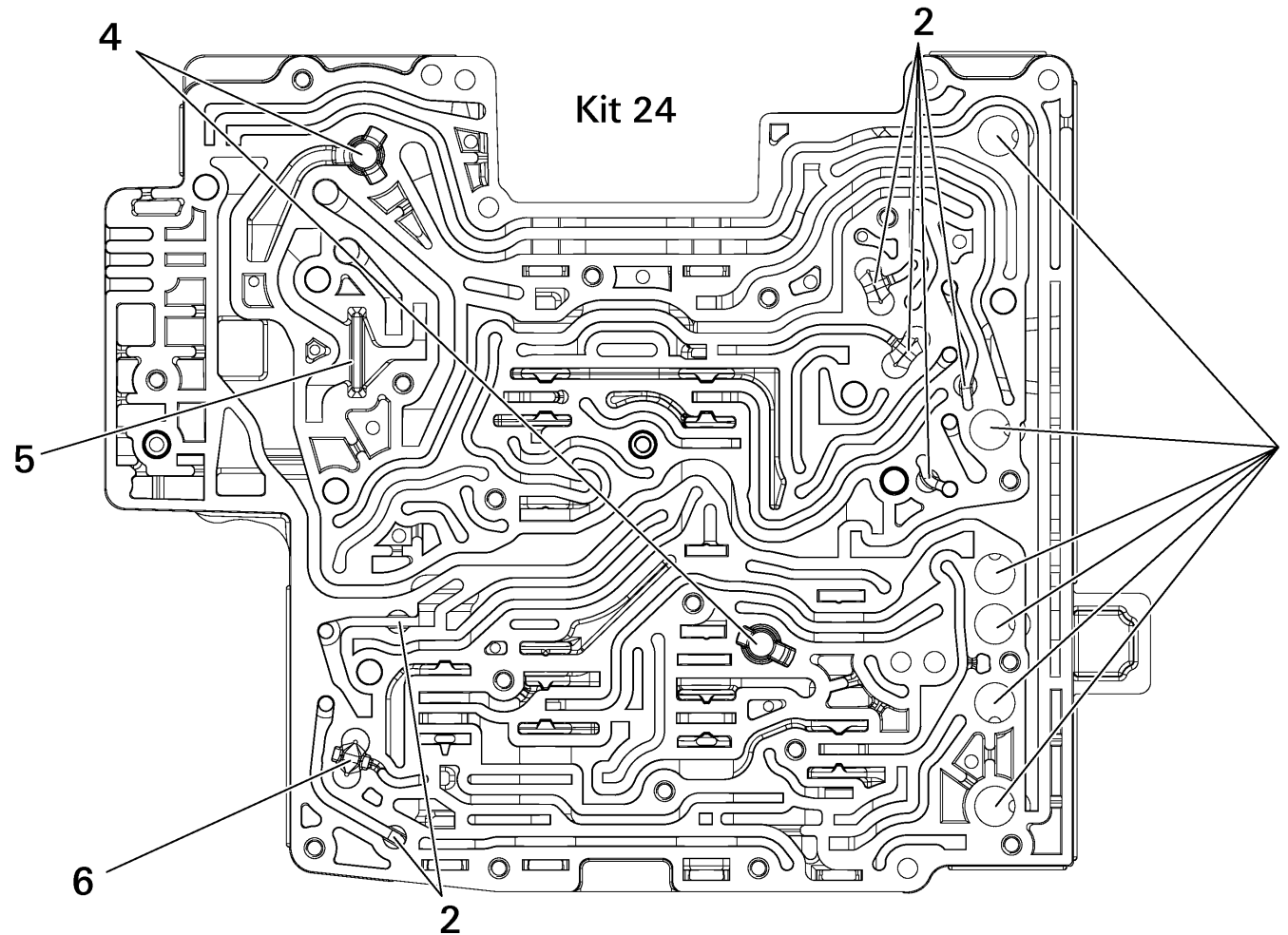

E20/2

Picture

Page 4 from 6

Material number: 1068.010.026

Picture: 1068_298_609-4

Material-assembly-group-no: 1068.298.522



6 HP 26 / ()
REPAIR KIT VALVE

1 - Kit 24

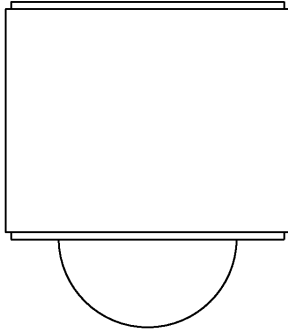

2 - Kit 24

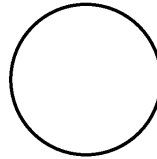

6 - Kit 24

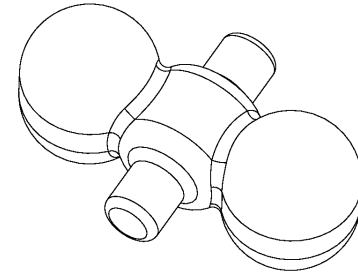

4 - Kit 24

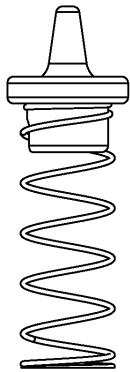

5 - Kit 24

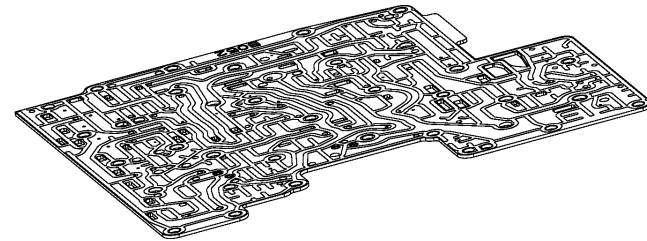
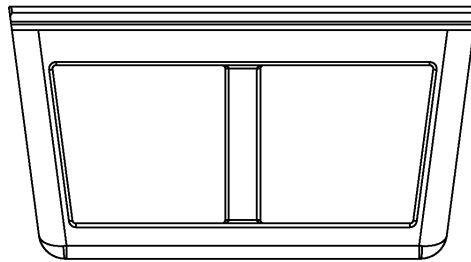

ET Zwischenblech

E20/2

Picture

Page 5 from 6

Material number: 1068.010.026

Picture: 114.D4.01-1

Material-assembly-group-no: 1068.298.522



6 HP 26 / ()
REPAIR KIT VALVE

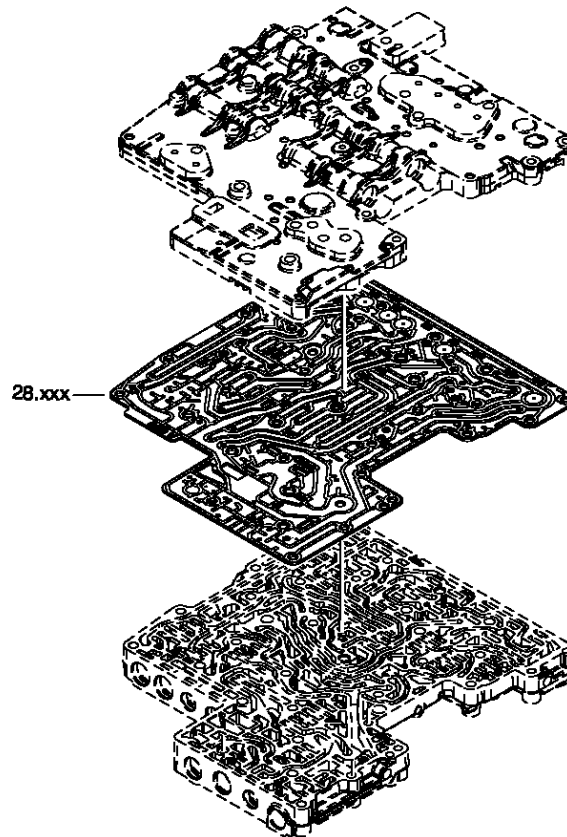

6 HP xx

Picture

Page 6 from 6

Material number: 1068.010.026

Picture: 114.G6.01-1

Material-assembly-group-no: 1068.298.522



6 HP 26 / ()
REPAIR KIT VALVE

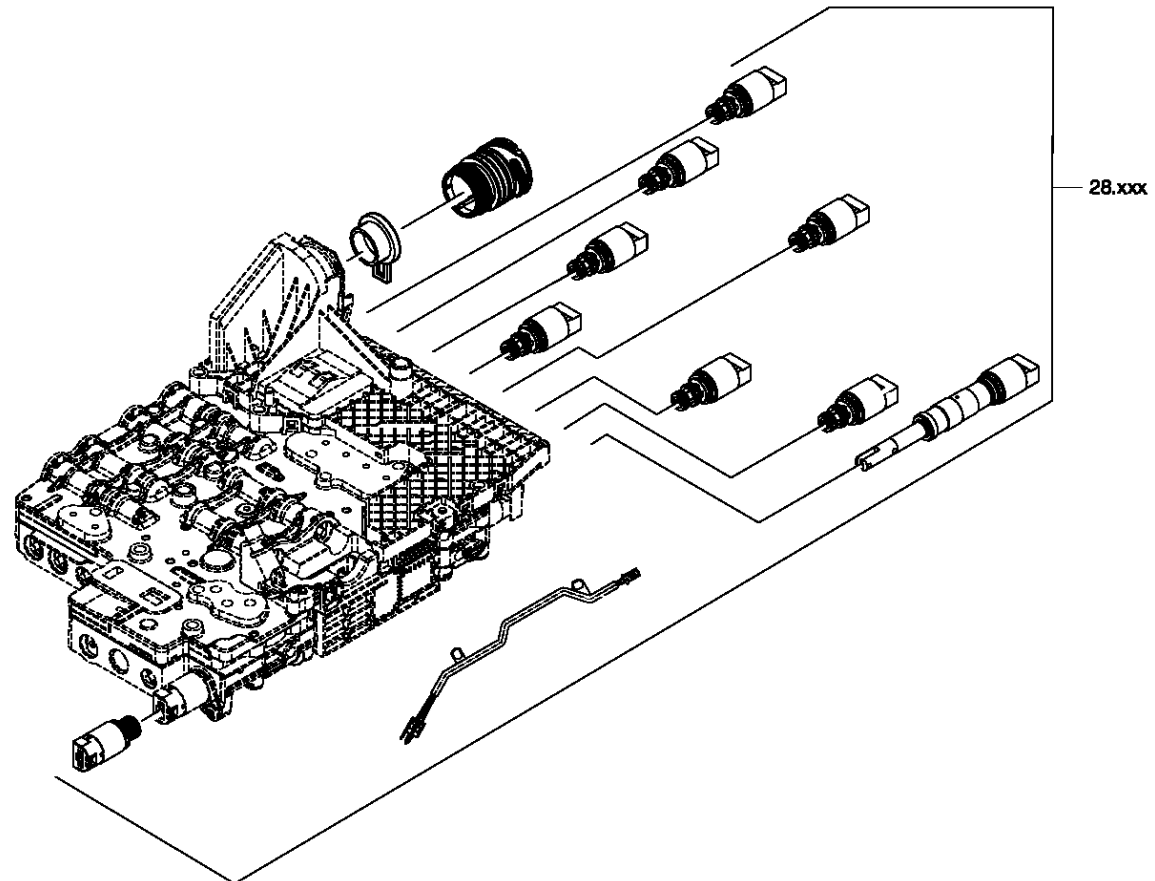

6 HP xx
E-Sch.

Picture

Page 1 from 6

Material number: 1068.010.026

Picture: 1068_298_609-1

Material-assembly-group-no: 1068.298.524



6 HP 26 / ()
REPAIR KIT VALVE

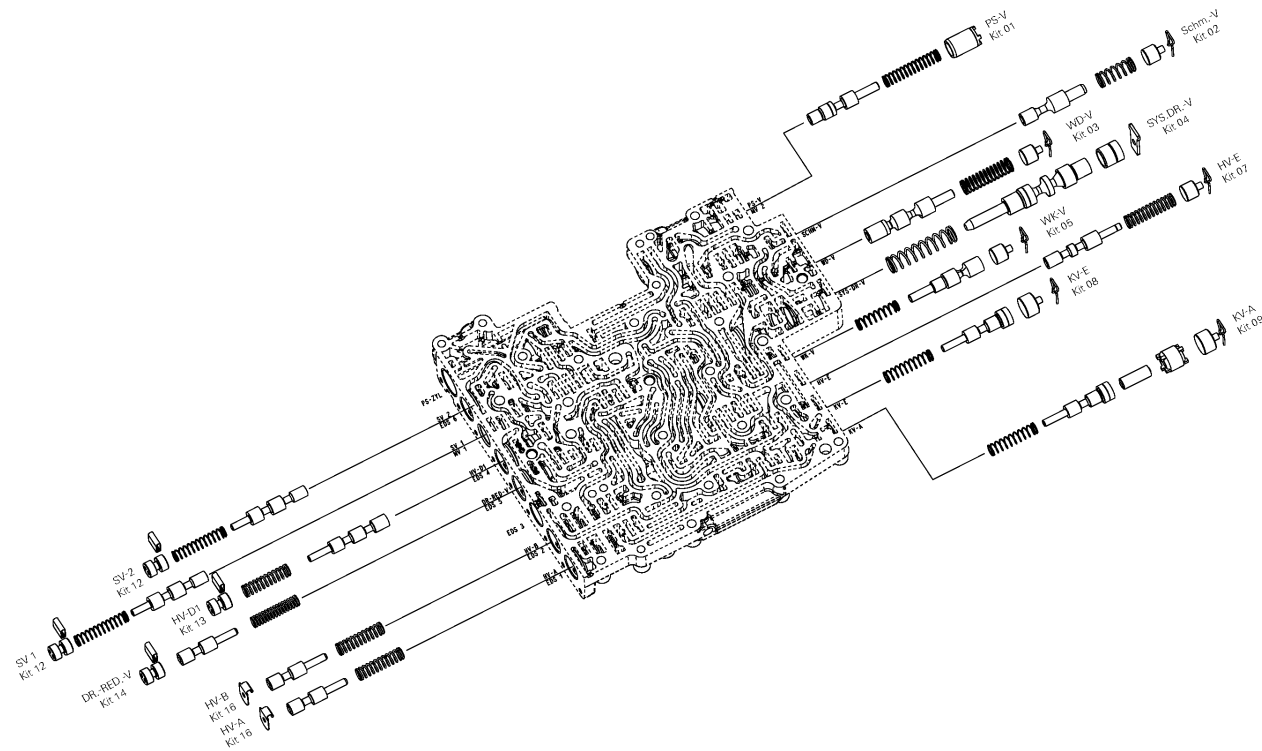

E20/2

Picture

Page 2 from 6

Material number: 1068.010.026

Picture: 1068_298_609-2

Material-assembly-group-no: 1068.298.524



6 HP 26 / ()
REPAIR KIT VALVE

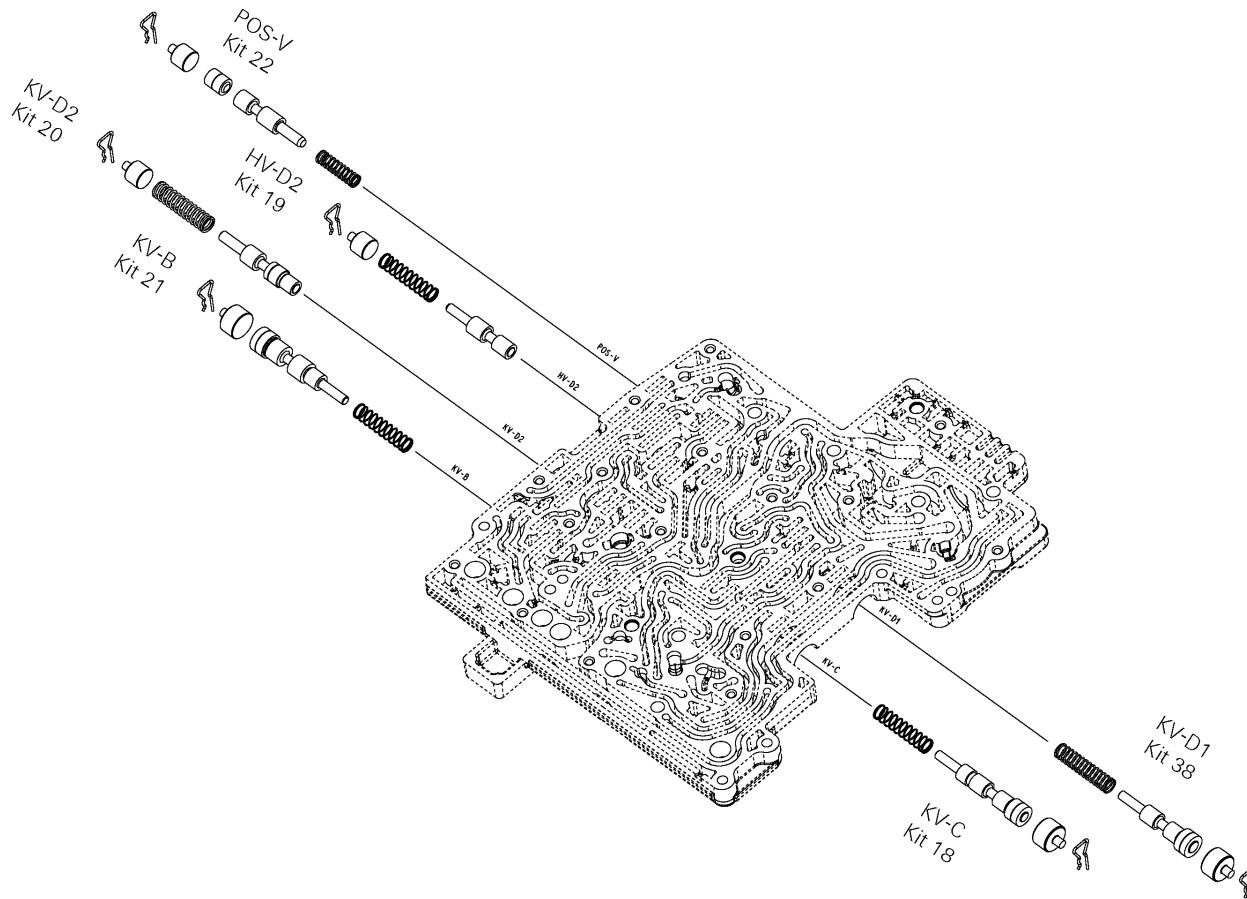

E20/2

Picture

Page 3 from 6

Material number: 1068.010.026

Picture: 1068_298_609-3

Material-assembly-group-no: 1068.298.524



6 HP 26 / ()
REPAIR KIT VALVE

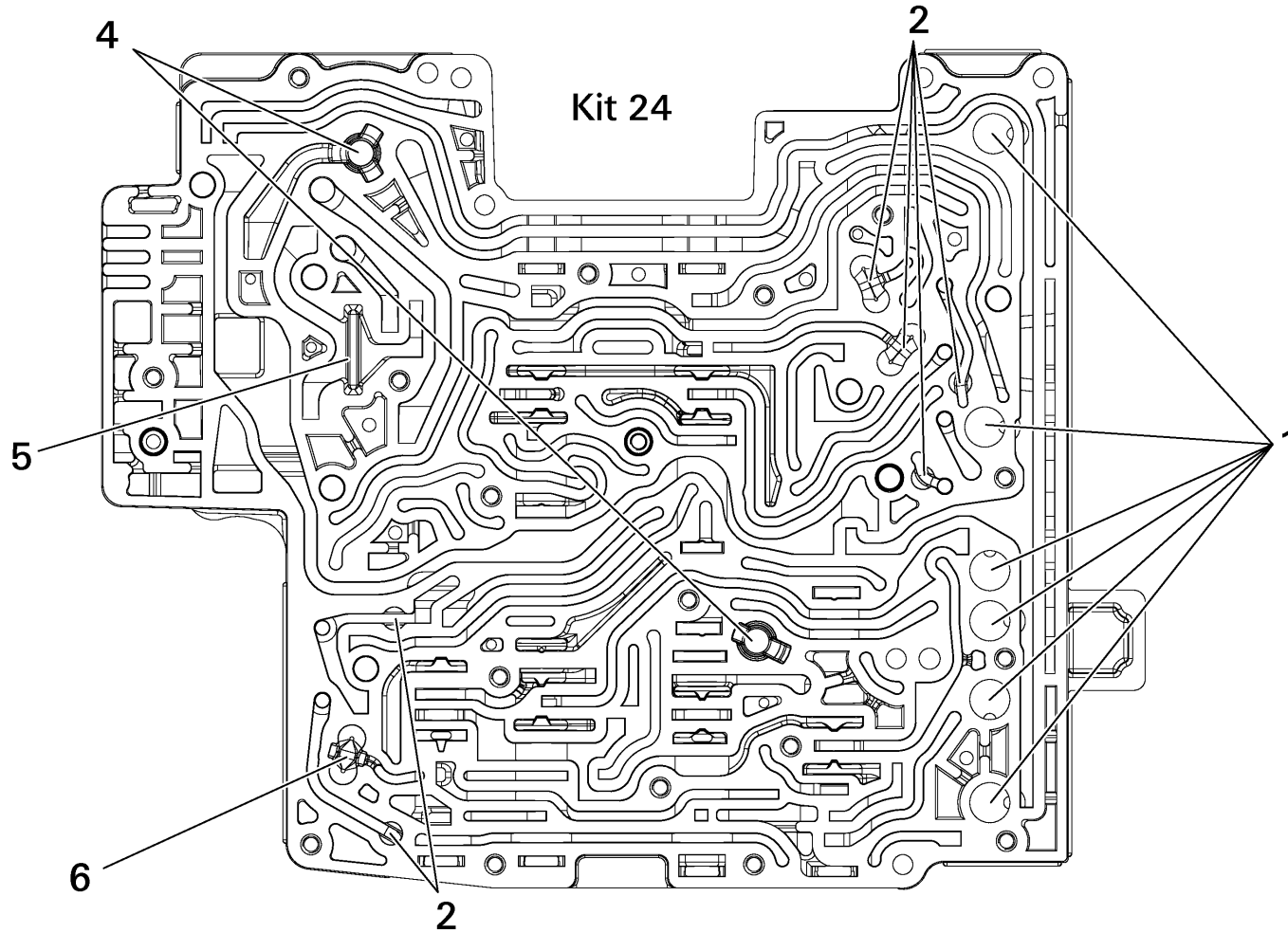

E20/2

Picture

Page 4 from 6

Material number: 1068.010.026

Picture: 1068_298_609-4

Material-assembly-group-no: 1068.298.524



6 HP 26 / ()
REPAIR KIT VALVE

1 - Kit 24

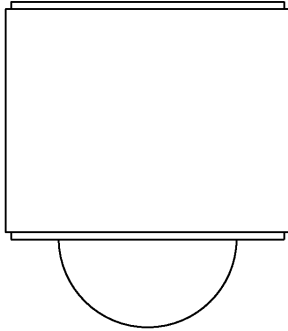

2 - Kit 24

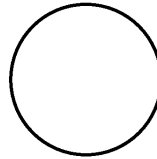

6 - Kit 24

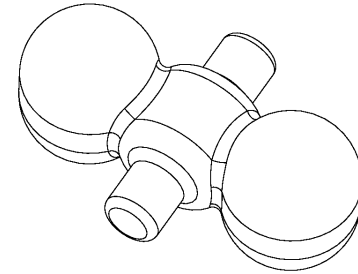

4 - Kit 24

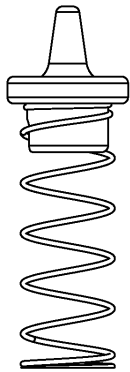

5 - Kit 24

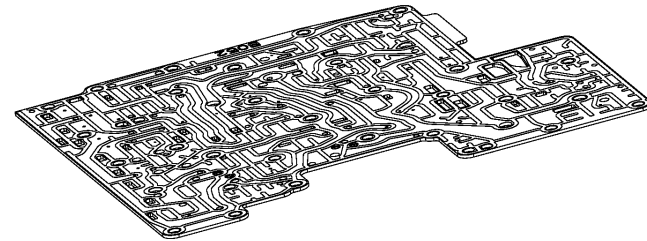
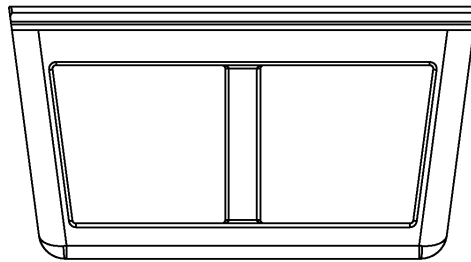

ET Zwischenblech

E20/2

Picture

Page 5 from 6

Material number: 1068.010.026

Picture: 114.D4.01-1

Material-assembly-group-no: 1068.298.524



6 HP 26 / ()
REPAIR KIT VALVE

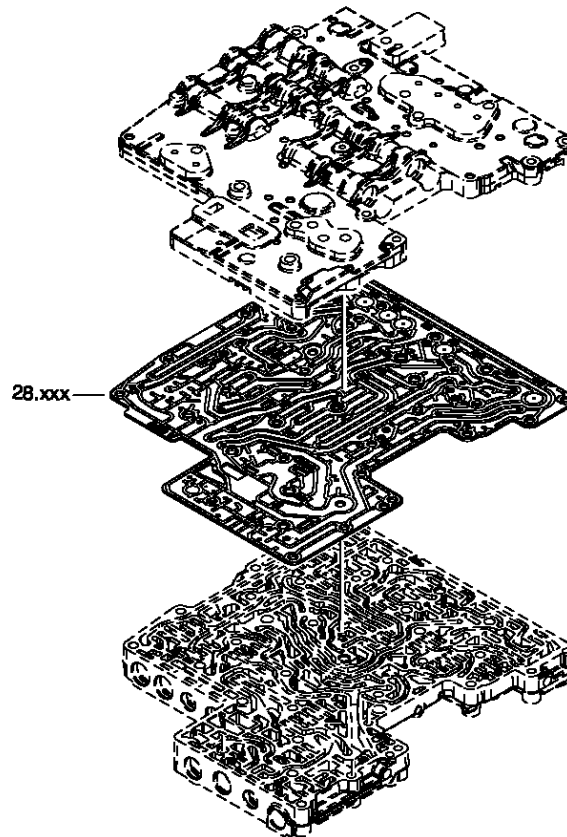

6 HP xx

Picture

Page 6 from 6

Material number: 1068.010.026

Picture: 114.G6.01-1

Material-assembly-group-no: 1068.298.524



6 HP 26 / ()
REPAIR KIT VALVE

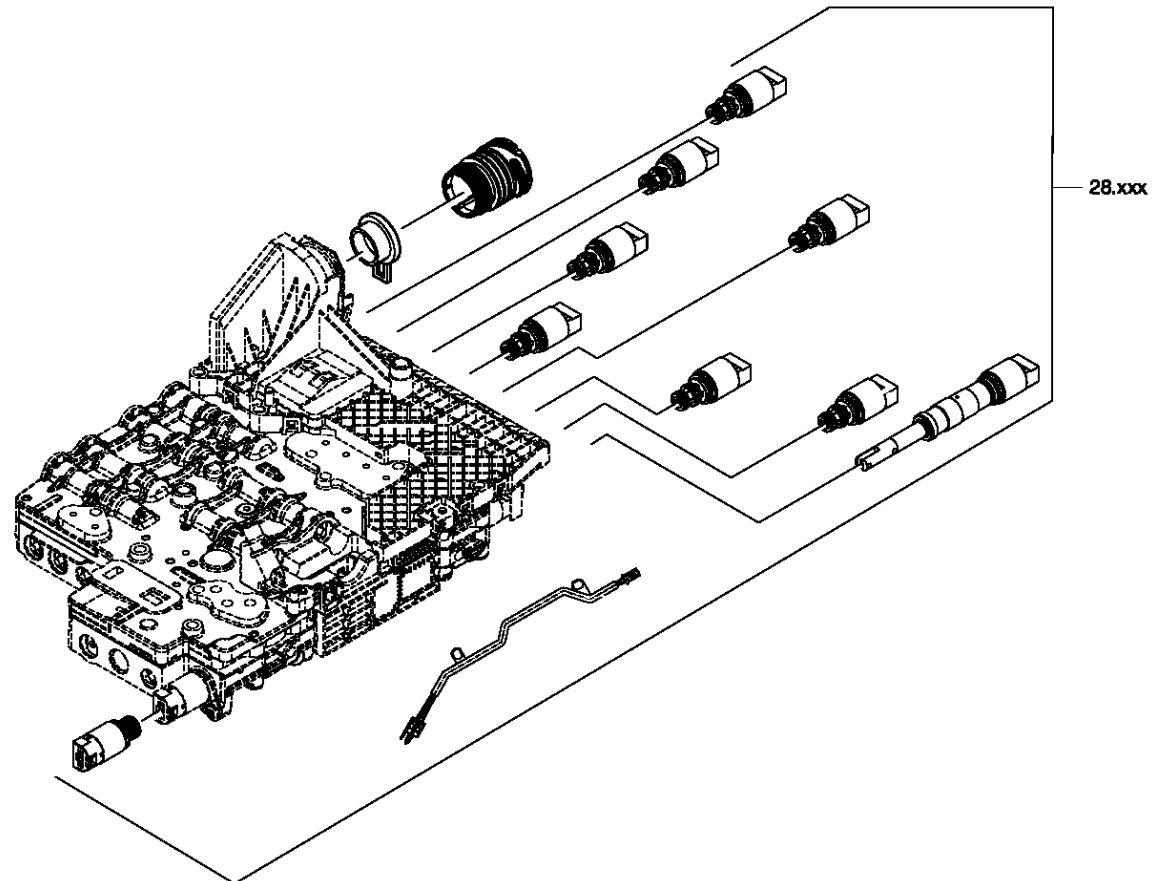

6 HP xx
E-Sch.

Picture

Page 2 from 6

Material number: 1068.010.026

Picture: 1068_298_609-2

Material-assembly-group-no: 1068.298.538



6 HP 26 / ()
REPAIR KIT VALVE

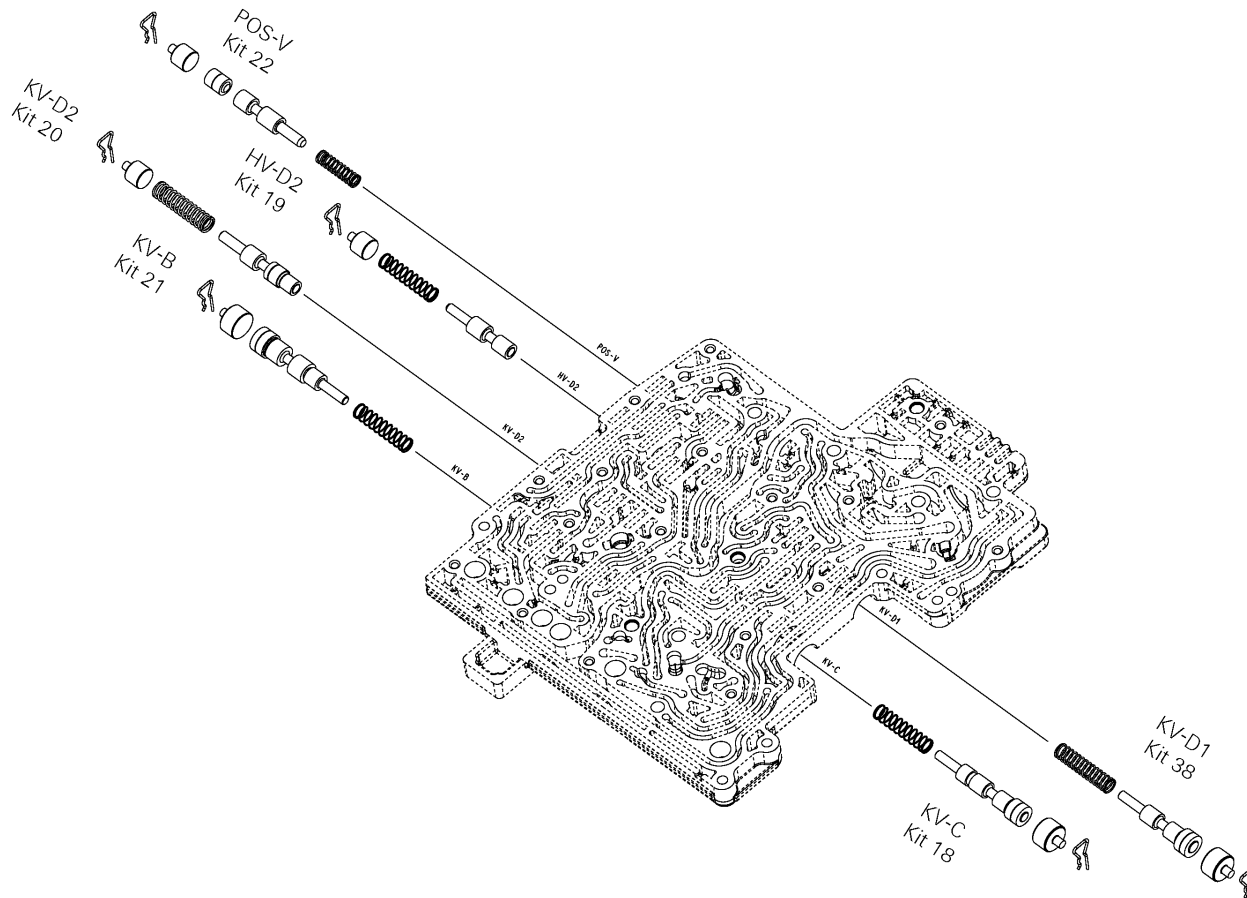

E20/2

Picture

Page 3 from 6

Material number: 1068.010.026

Picture: 1068_298_609-3

Material-assembly-group-no: 1068.298.538



6 HP 26 / ()
REPAIR KIT VALVE

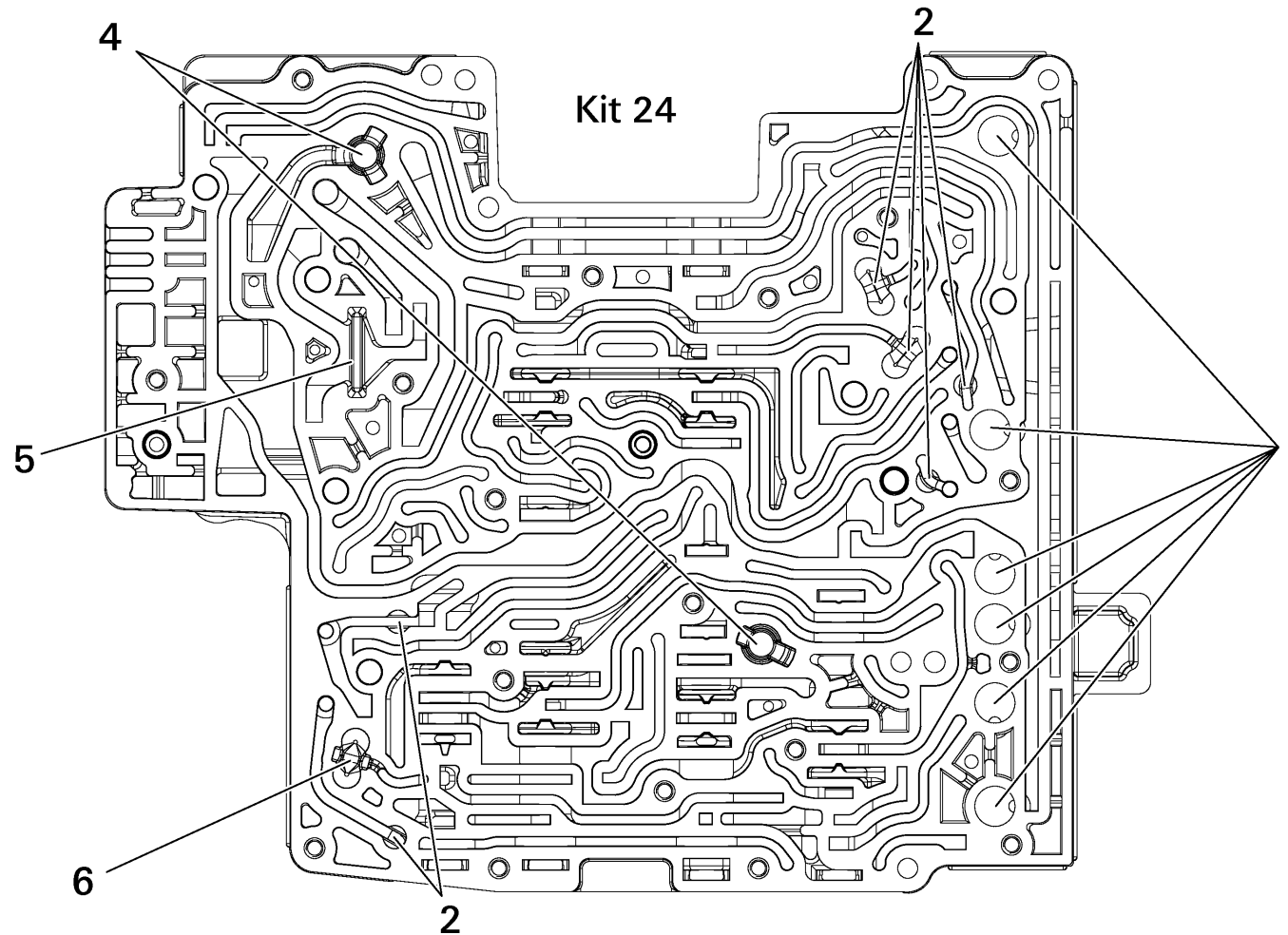

E20/2

Picture

Page 4 from 6

Material number: 1068.010.026

Picture: 1068_298_609-4

Material-assembly-group-no: 1068.298.538



6 HP 26 / ()
REPAIR KIT VALVE

1 - Kit 24

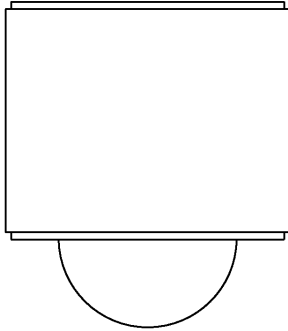

2 - Kit 24

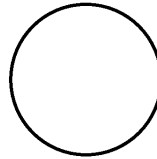

6 - Kit 24

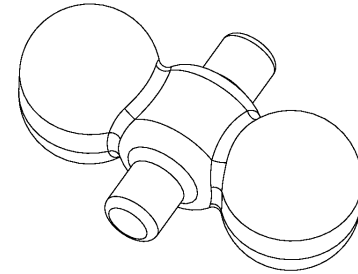

4 - Kit 24

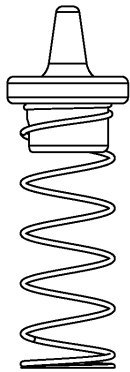

5 - Kit 24

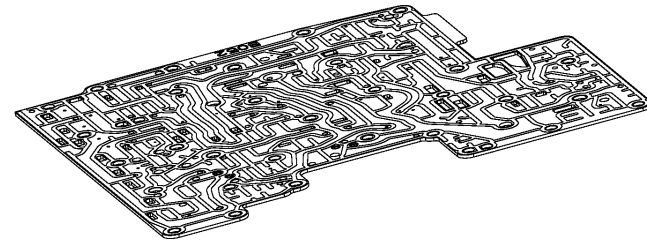
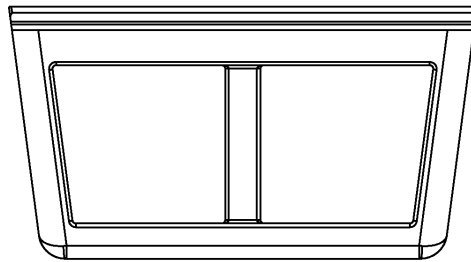

ET Zwischenblech

E20/2

Picture

Page 5 from 6

Material number: 1068.010.026

Picture: 114.D4.01-1

Material-assembly-group-no: 1068.298.538



6 HP 26 / ()
REPAIR KIT VALVE

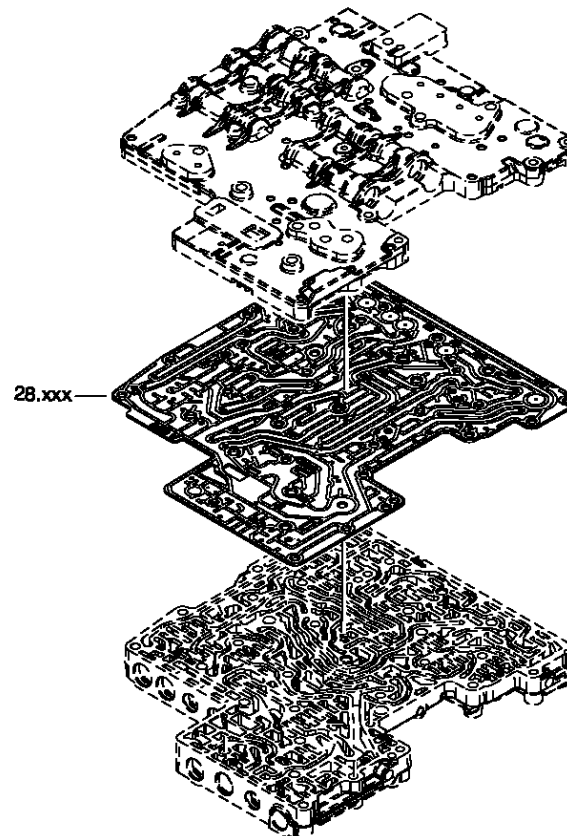

6 HP xx

Picture

Page 6 from 6

Material number: 1068.010.026

Picture: 114.G6.01-1

Material-assembly-group-no: 1068.298.538



6 HP 26 / ()
REPAIR KIT VALVE

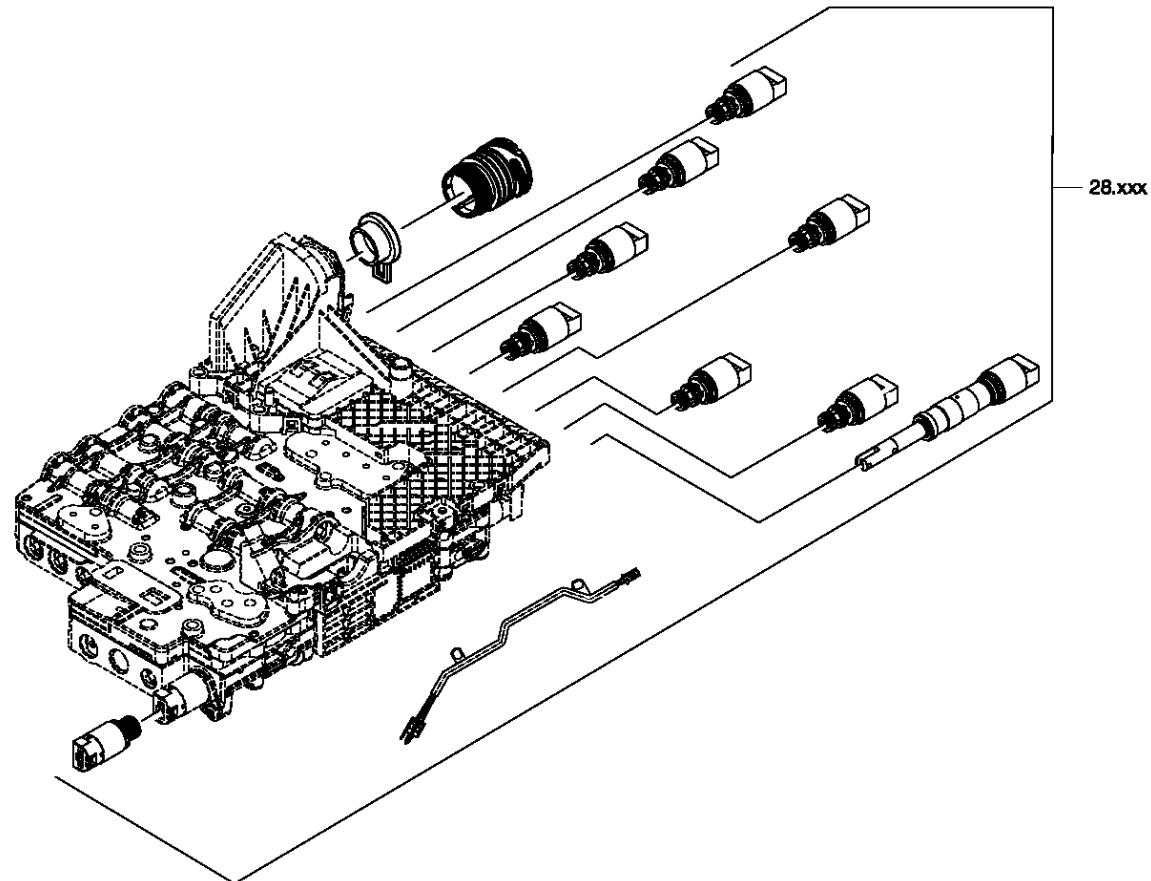

6 HP xx
E-Sch.

Picture

Page 1 from 6

Material number: 1068.010.026

Picture: 1068_298_609-1

Material-assembly-group-no: 1068.298.609



6 HP 26 / ()
REPAIR KIT MECHATRONIC

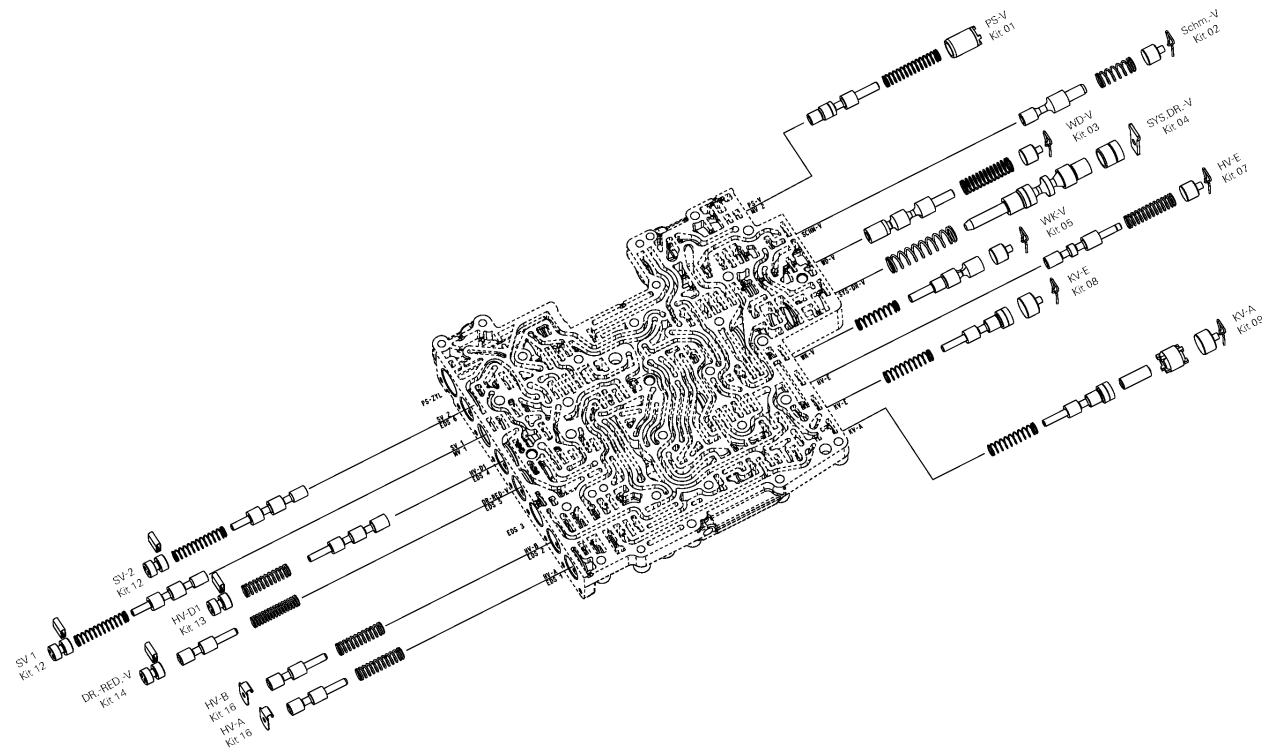

E20/2

Picture

Page 2 from 6

Material number: 1068.010.026

Picture: 1068_298_609-2

Material-assembly-group-no: 1068.298.609



6 HP 26 / ()
REPAIR KIT MECHATRONIC

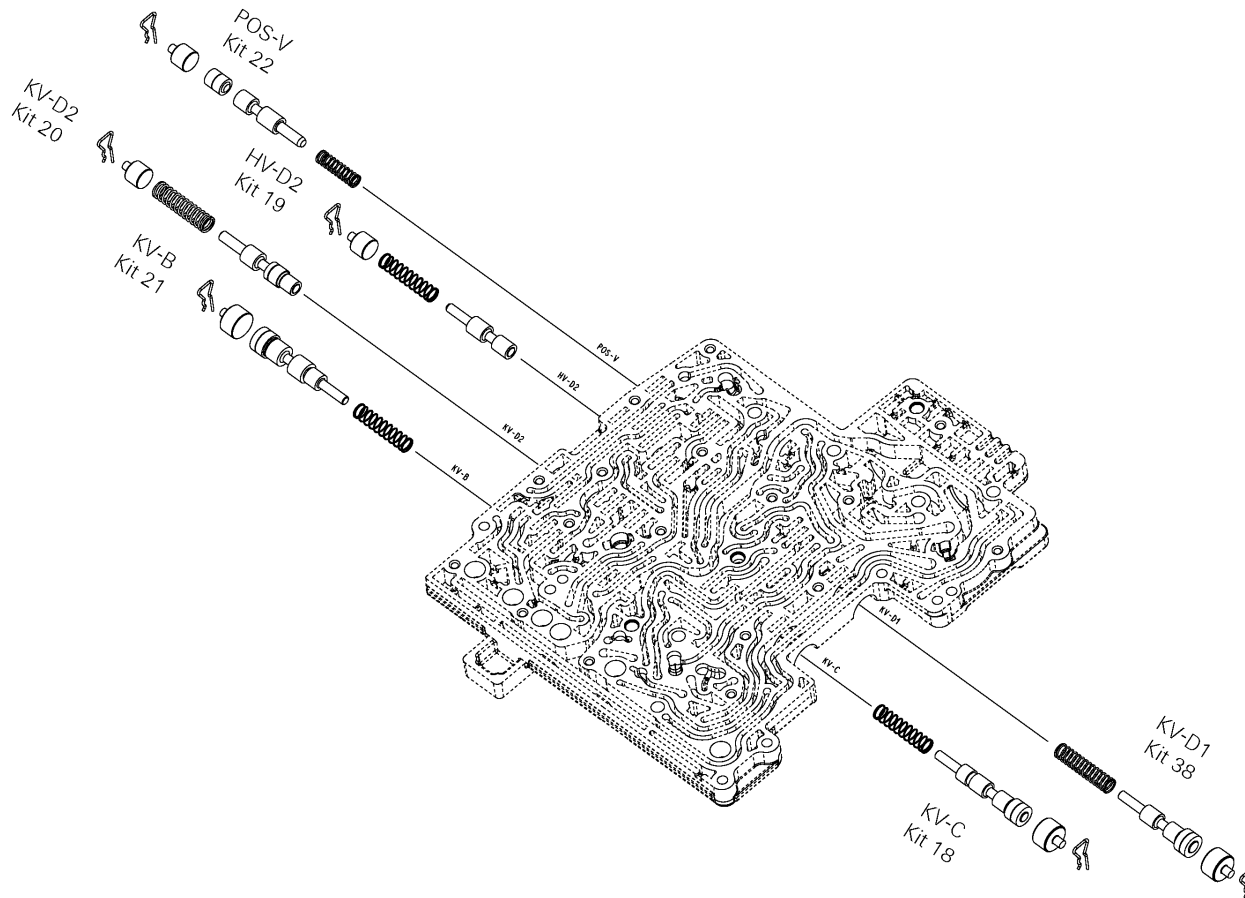

E20/2

Picture

Page 3 from 6

Material number: 1068.010.026

Picture: 1068_298_609-3

Material-assembly-group-no: 1068.298.609



6 HP 26 / ()
REPAIR KIT MECHATRONIC

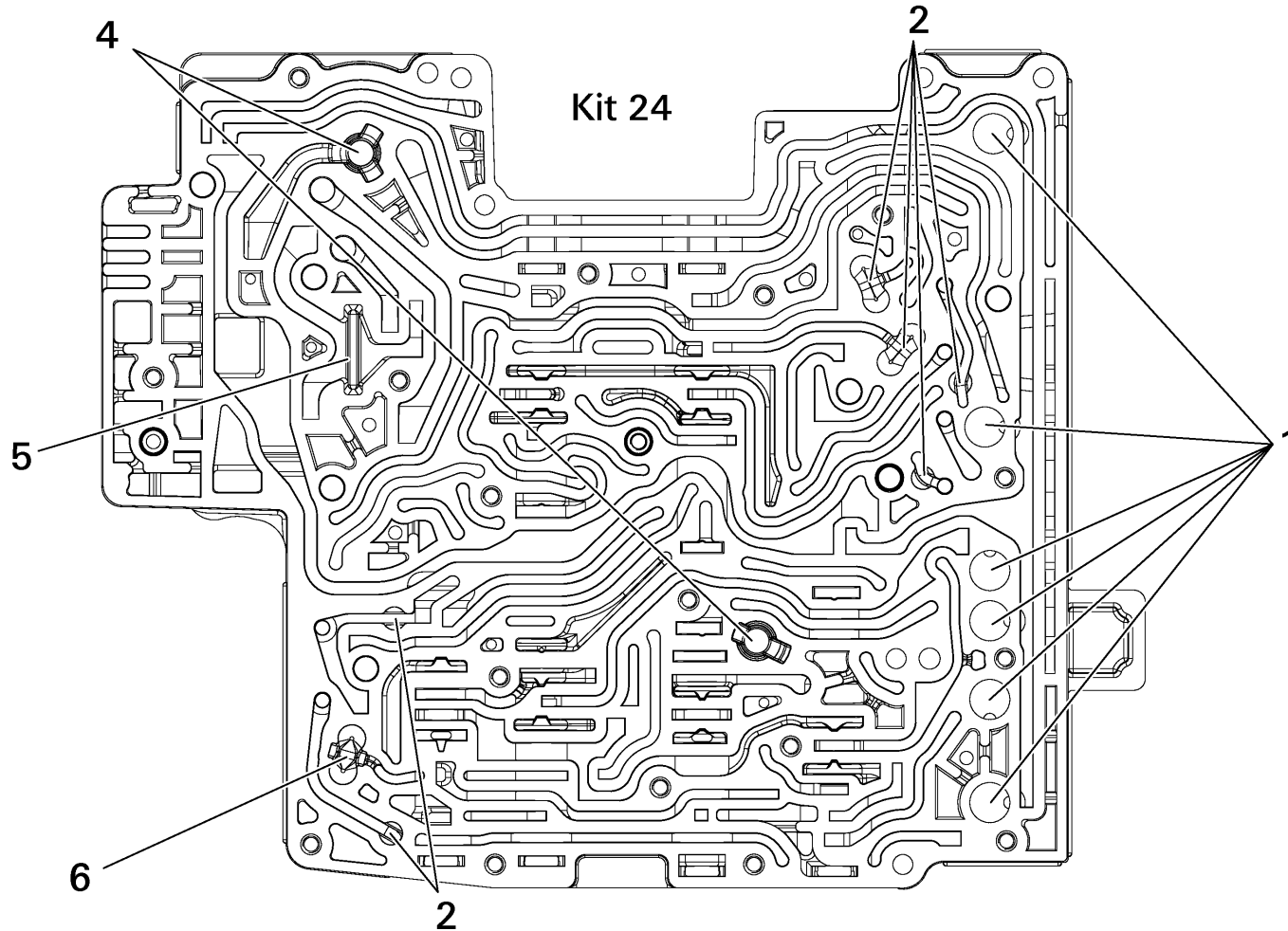

E20/2

Picture

Page 4 from 6

Material number: 1068.010.026

Picture: 1068_298_609-4

Material-assembly-group-no: 1068.298.609



6 HP 26 / ()
REPAIR KIT MECHATRONIC

1 - Kit 24

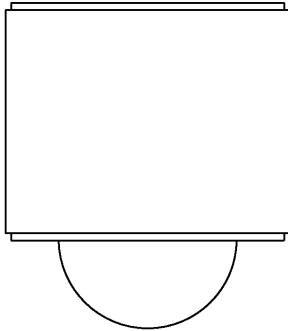

2 - Kit 24

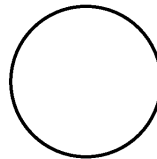

6 - Kit 24

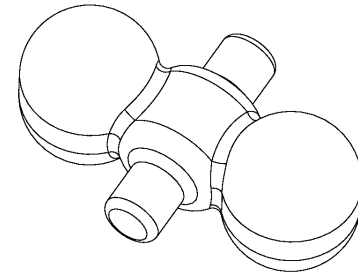

4 - Kit 24

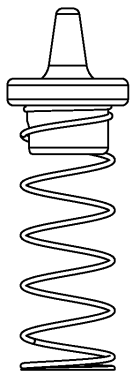

5 - Kit 24

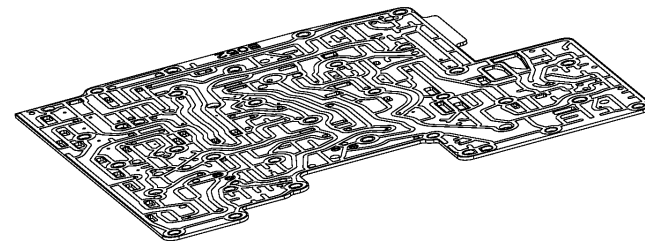
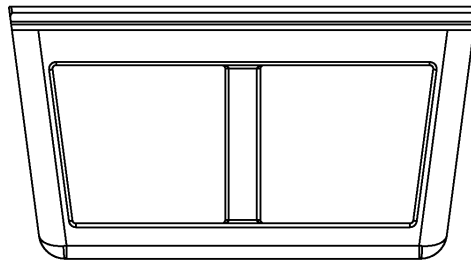

ET Zwischenblech

E20/2

Picture

Page 5 from 6

Material number: 1068.010.026

Picture: 114.D4.01-1

Material-assembly-group-no: 1068.298.609



6 HP 26 / ()
REPAIR KIT MECHATRONIC

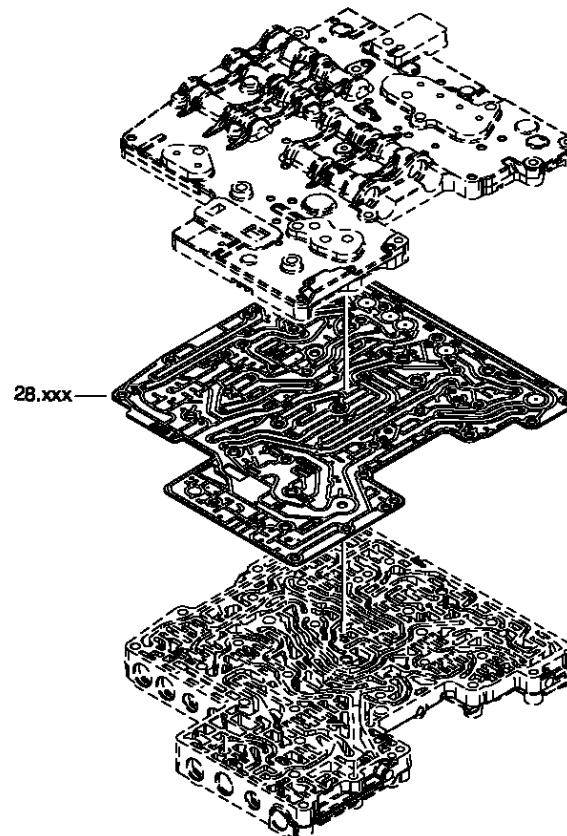

6 HP xx

Picture

Page 6 from 6

Material number: 1068.010.026

Picture: 114.G6.01-1

Material-assembly-group-no: 1068.298.609



6 HP 26 / ()
REPAIR KIT MECHATRONIC

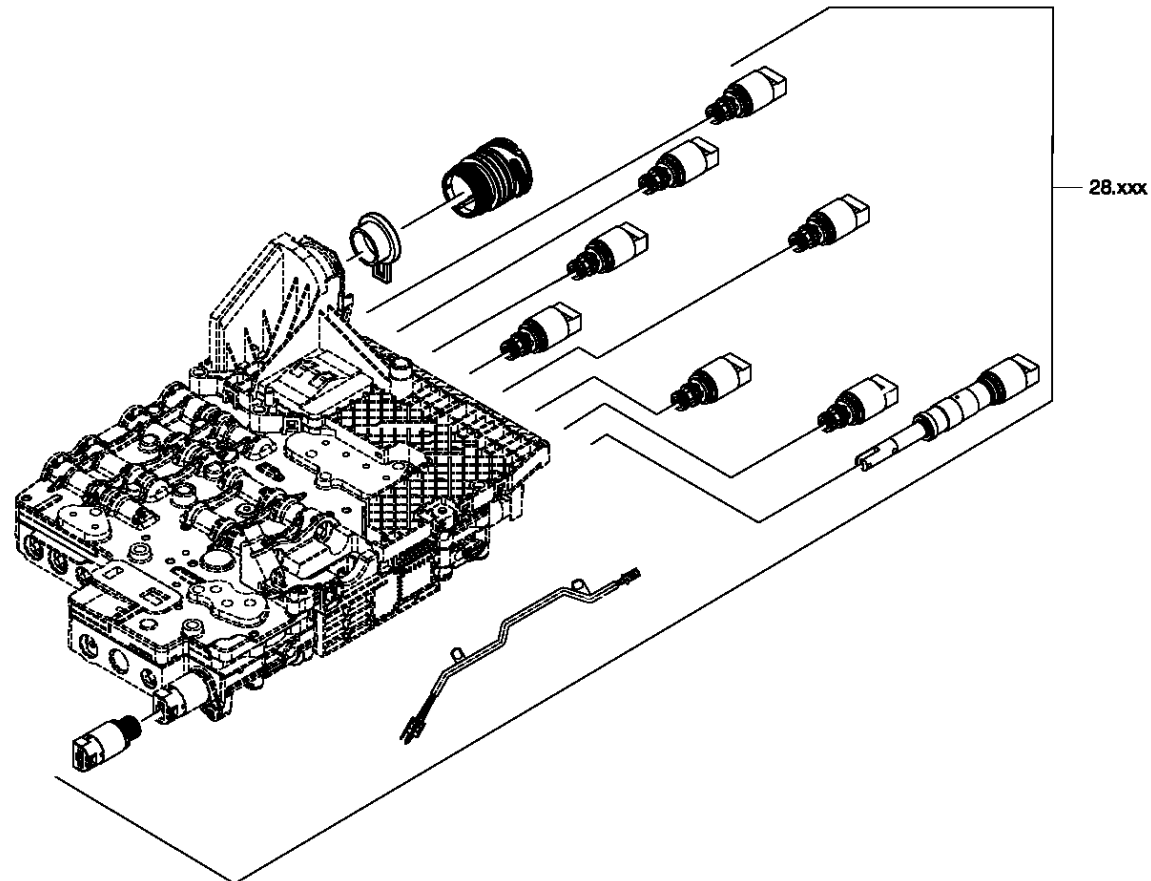

6 HP xx
E-Sch.